



# ALTAIR

Altair<sup>®</sup> FluxMotor<sup>®</sup> 2022.3

Synchronous Machines - Permanent Magnets - Inner & Outer rotor

Motor Factory – Design

General user information

## Contents

<b>1 Synchronous machines – Permanent magnets – Inner rotor</b>	<b>6</b>
<b>1.1 Home page view</b>	<b>6</b>
<b>1.2 Topology</b>	<b>7</b>
1.2.1 Overview	7
1.2.2 Inputs	8
1.2.2.1 Method to define the airgap	8
1.2.2.2 Structural data	8
1.2.3 Advice for use	9
<b>1.3 Housing</b>	<b>10</b>
1.3.1 Overview	10
1.3.2 Housing - Frame	11
1.3.2.1 Type of frame	11
1.3.2.2 Combination between lamination outer shape and frame types	12
1.3.3 Housing – Fin	13
1.3.3.1 Overview	13
1.3.3.2 Type of fins	13
1.3.3.3 Parallel type fins – Topologies and dimensions	14
1.3.3.4 Radial type fins – Topologies and dimensions	15
1.3.4 Housing – Cooling circuit	17
1.3.4.1 Overview	17
1.3.4.2 Type of cooling circuits	17
1.3.4.3 Cooling circuits – Topologies and dimensions	18
<b>1.4 Shaft</b>	<b>22</b>
1.4.1 Overview	22
1.4.2 Shaft type	23
1.4.3 Shaft - Inputs	23
1.4.4 Shaft – Bearing	24
1.4.4.1 Overview	24
1.4.4.2 Shaft-Bearing type and characteristics	25
1.4.4.3 Shaft-Bearing input parameters	26
<b>1.5 Magnet</b>	<b>27</b>
1.5.1 Overview	27
<b>1.6 Magnet design</b>	<b>28</b>
1.6.1 Choose a magnet topology	28
1.6.1.1 Attached documents – Additional information	28
1.6.1.2 Inputs / Outputs	29
1.6.2 Magnet – Skew	30
1.6.2.1 Overview	30
1.6.2.2 Set a skew angle	31
<b>1.7 Polarization</b>	<b>32</b>
1.7.1 Overview	32
1.7.2 Choice of polarization	32
1.7.2.1 Polarization coordinate system	32
1.7.2.2 Polarization orientation	32
1.7.2.3 Polarization orientation illustrations	33
<b>1.8 Slot</b>	<b>35</b>
1.8.1 Overview	35
1.8.2 Slot - Design	36

1.8.2.1	Slot shape - Choose a slot topology	36
1.8.2.2	Attached documents – Additional information	36
1.8.2.3	Inputs / Outputs	37
1.8.3	Slot – Skew	38
1.8.3.1	Overview	38
1.8.3.2	Set a skew angle	39
1.8.4	Slot – Lamination	40
1.8.4.1	Overview	40
1.8.4.2	Circular shape lamination	40
1.8.4.3	Square shape lamination	41
<b>1.9</b>	<b>Winding</b>	<b>43</b>
<b>1.10</b>	<b>External cooling</b>	<b>45</b>
1.10.1	Overview	45
1.10.2	Advice for use	46
1.10.2.1	Hypothesis on fluidic computations	46
1.10.2.2	Validity domain of the fluidic computations	46
1.10.2.3	Frame convection and cooling circuit convection	46
1.10.2.4	Temperature considered for fluidic computations	46
1.10.3	Fluidic – Inputs	47
1.10.3.1	Overview	47
1.10.3.2	Natural convection	48
1.10.3.3	Forced convection	49
1.10.4	Radiation – Inputs	51
1.10.5	X-Factors – Inputs	52
1.10.5.1	Overview	52
1.10.5.2	Calibration factors	53
1.10.5.3	Model evaluation	53
1.10.6	External cooling outputs	54
1.10.6.1	Frame external area	54
1.10.6.2	Cooling circuit	56
<b>1.11</b>	<b>Internal cooling</b>	<b>57</b>
1.11.1	Overview	57
1.11.2	Advice for use	58
1.11.2.1	Hypothesis on fluidic computations	58
1.11.2.2	Validity domain of the fluidic computations	58
1.11.2.3	Natural convection on end windings	58
1.11.2.4	Temperatures considered for fluidic computations	58
1.11.2.5	Interface thickness usage	58
1.11.2.6	Radiation from the shaft	58
1.11.3	Fluidic – Inputs	59
1.11.3.1	Natural convection	60
1.11.3.2	Forced convection	60
1.11.4	Radiation – Inputs	64
1.11.5	Interface – Inputs	65
1.11.6	Slot model – Inputs	66
1.11.7	X-Factors	67
1.11.7.1	X-Factor mapping	68
1.11.8	Internal cooling outputs	72
1.11.8.1	End-space	72
1.11.8.2	Airgap	72
1.11.8.3	Interface conduction resistances	72
1.11.8.4	Slot model characteristic	72
<b>1.12</b>	<b>Materials</b>	<b>73</b>
1.12.1	Overview	73

1.12.2	Rotor inputs / outputs	74
1.12.3	How to assign materials – Example for rotor lamination	75
1.12.4	How to assign materials – Example for stator lamination	76
1.12.5	Materials for the winding	77
1.12.6	Material datasheet	78
<b>2</b>	<b>Synchronous machines – Permanent magnets – Outer rotor</b>	<b>79</b>
<b>2.1</b>	<b>Home page view</b>	<b>79</b>
<b>2.2</b>	<b>Topology</b>	<b>80</b>
2.2.1	Overview	80
2.2.2	Inputs	81
2.2.2.1	Method to define the airgap	81
2.2.2.2	Structural data	81
2.2.3	Advice for use	82
<b>2.3</b>	<b>Shaft</b>	<b>83</b>
2.3.1	Overview	83
2.3.2	Shaft type	84
2.3.3	Shaft topology	85
2.3.4	Inputs	86
2.3.5	Display Fix and rotating parts	87
<b>2.4</b>	<b>Housing</b>	<b>88</b>
2.4.1	Overview	88
2.4.2	Frame design area	89
<b>2.5</b>	<b>Magnet</b>	<b>90</b>
2.5.1	Overview	90
2.5.2	Magnet - Design	91
2.5.2.1	Choose a magnet topology	91
2.5.2.2	Attached documents – Additional information	91
2.5.2.3	Inputs / Outputs	92
2.5.3	Magnet – Skew	93
2.5.3.1	Overview	93
2.5.3.2	Set a skew angle	94
<b>2.6</b>	<b>Polarization</b>	<b>95</b>
2.6.1	Overview	95
2.6.2	Choice of polarization	95
2.6.2.1	Polarization coordinate system	95
2.6.2.2	Polarization orientation	95
2.6.2.3	Polarization orientation illustrations	96
<b>2.7</b>	<b>Slot</b>	<b>98</b>
2.7.1	Overview	98
2.7.2	Slot - Design	99
2.7.2.1	Choose a slot topology	99
2.7.2.2	Attached documents – Additional information	99
2.7.2.3	Inputs / Outputs	100
2.7.3	Slot – Skew	101
2.7.3.1	Overview	101
2.7.3.2	Set a skew angle	102
<b>2.8</b>	<b>Winding</b>	<b>103</b>
<b>2.9</b>	<b>Materials</b>	<b>105</b>
2.9.1	Overview	105
2.9.2	Rotor Inputs / Outputs	106



2.9.3	How to assign materials? – Example for rotor lamination .....	107
2.9.4	How to assign materials? – Example for stator laminations .....	108
2.9.5	Materials for the winding .....	109
2.9.6	Material datasheet .....	110

# 1 SYNCHRONOUS MACHINES – PERMANENT MAGNETS – INNER ROTOR

## 1.1 Home page view

The Motor Factory – DESIGN area is the first environment of Motor Factory. It is composed of five main zones. This is the guided line to design your machine.

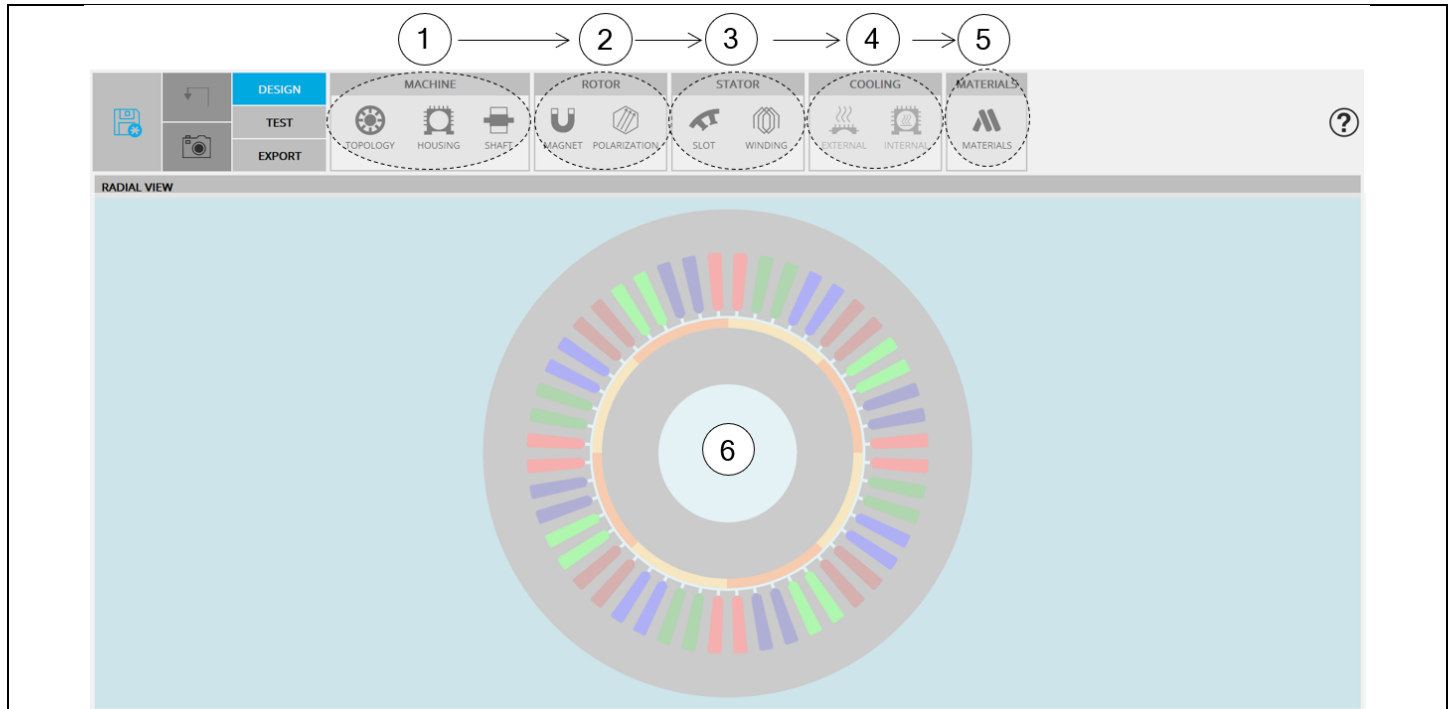

Motor Factory – DESIGN area view – Example for synchronous machine – Permanent magnets

Zone 1 <b>MACHINE</b>	<p>Definition of general data of the machine depending on the considered type of machine</p> <ul style="list-style-type: none"> <li>• Topology with overall dimensions, No. slots, No. poles,</li> <li>• Housing, Frame, Fins and cooling circuit topologies and dimensions</li> <li>• Shaft, type, Bearings and dimensions</li> </ul>
Zone 2 <b>ROTOR</b>	<p>Access to the main functions to design the ROTOR and its corresponding subsets:</p> <ul style="list-style-type: none"> <li>• Magnet, Polarization</li> </ul>
Zone 3 <b>STATOR</b>	<p>Access to the main functions to design the STATOR and its corresponding subsets:</p> <ul style="list-style-type: none"> <li>• Slot, Winding</li> </ul>
Zone 4 <b>COOLING</b>	<p>Define external and internal cooling parameters Convection, radiation, conductivity parameters and X-factors</p> <p>Note: By default, accesses to External cooling and Internal cooling environments are locked. <b>External cooling</b> is unlocked when a frame is defined (Housing / Frame environment) <b>Internal cooling</b> is unlocked when a frame is defined (Machine / Housing / Frame environment) and a shaft with bearings are defined (Machine / Shaft / Bearing environment).</p>
Zone 5 <b>MATERIALS</b>	<p>Area to select all the materials needed to build the machine, rotor, stator and the cooling</p>
Zone 6 <b>VIEW</b>	<p>Visualization of the motor radial view. The winding (automatically defined) is shown. Note: Graphic functions like export picture and zoom are available on this view by right clicking on mouse (right part of the panel). See system functions, graphic management to get more information.</p>

## 1.2 Topology

### 1.2.1 Overview

The first step of the design consists of defining structural data of the machine. However, at any time, it is possible to reach and modify the structural data from the Motor Factory design environment. Here is the process to modify the structural data from the general data panel.

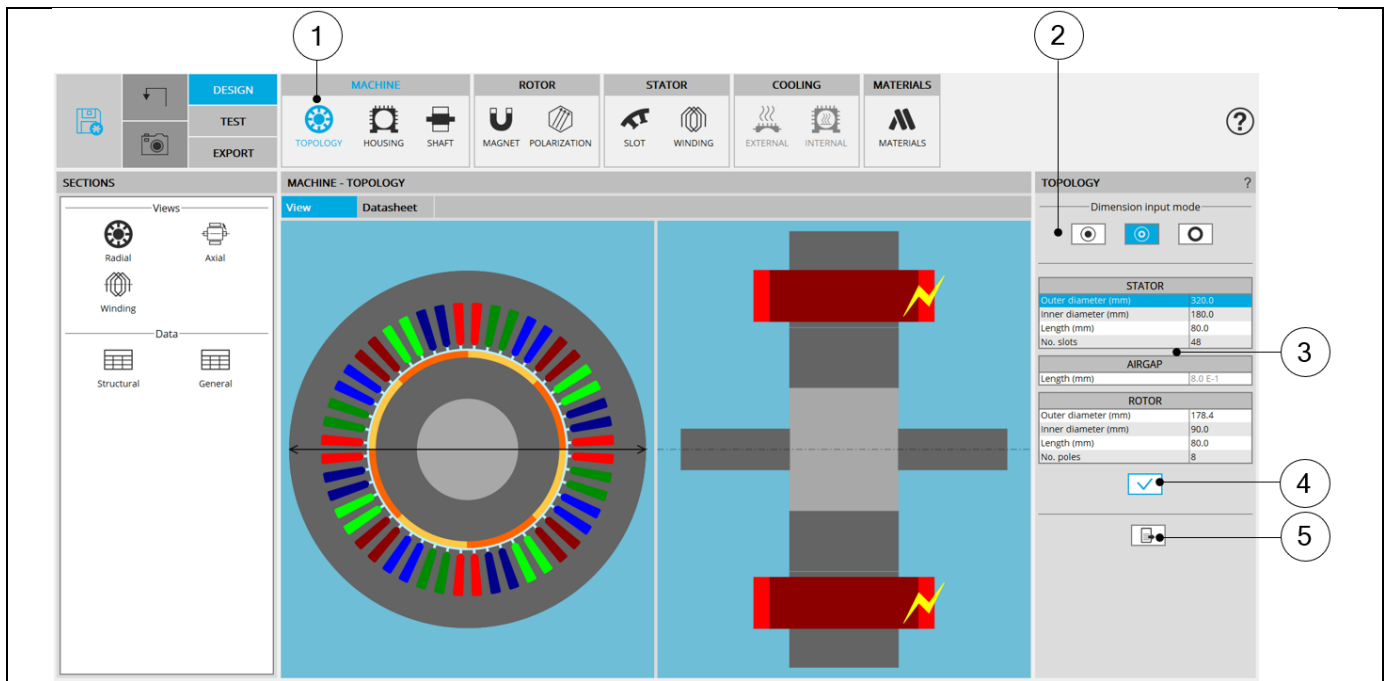

Process to modify the structural data

1	Open the TOPOLOGY panel (Click on the icon TOPOLOGY)
2	Choose a way to define the diameters of the machine and the airgap See additional information below.
3	Modify the values of structural data – When relevant the corresponding arrow is displayed on the view
4	Button to apply inputs
5	Icon to export data into a *.txt or *.xlsx file - Please see above illustration

For more details concerning general functions of Motor Factory Design environment, please refer to the document ".MotorFactory\_2022.3\_Introduction".

## 1.2.2 Inputs

### 1.2.2.1 Method to define the airgap

In the topology sub area, three ways are possible to define the structural data of the machine based upon the diameters and the airgap. They are illustrated below.

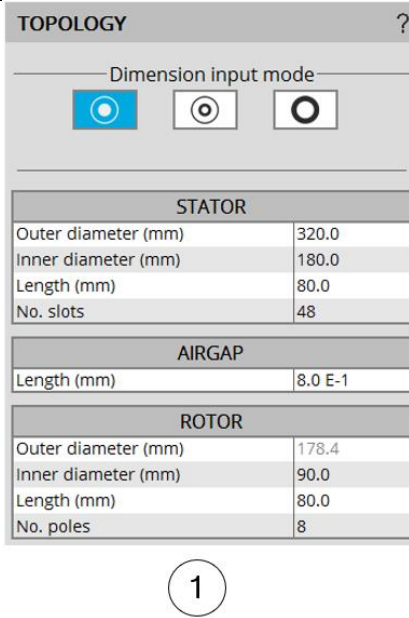
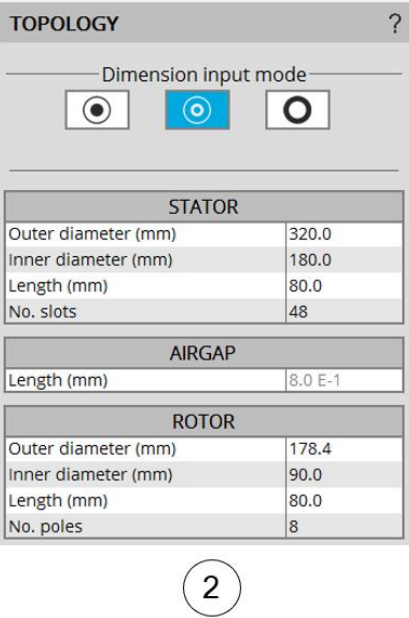
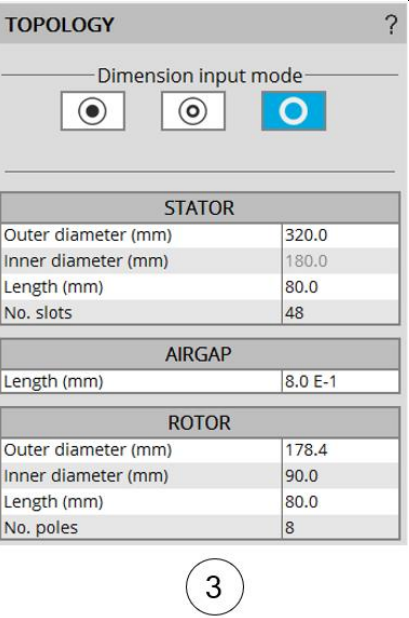
	①	②	③
			
	Method to define the diameters of machine and the airgap Example for a Synchronous Machine with Permanent Magnets and Inner Rotor		
1	User defines the inner diameter of the stator and the airgap. The outer diameter of the rotor is automatically deduced (automatically computed value is displayed in grey color).		
2	User defines the inner diameter of the stator and the outer diameter of the rotor. The airgap is automatically deduced (automatically computed value is displayed in grey color).		
3	User defines the outer diameter of the rotor and the airgap. The inner diameter of the stator is automatically deduced (automatically computed value is displayed in grey color).		

### 1.2.2.2 Structural data

Here are the user input parameters to define the structural data of the machine:

- Stator outer diameter
- Stator inner diameter
- Stator length
- Number of slots
- Airgap length
- Rotor outer diameter
- Rotor inner diameter
- Rotor length
- Number of poles

The modification of the structural data can lead to the modification of the user input parameters in defining dimensions of parts like slots or magnets. When modifications occur, a warning is displayed.

The application ranges for structural data are defined below.

### 1.2.3 Advice for use

The choice of diameters is possible over the range [1, 20000] mm.

The number of slots is possible over the range [3, 2400].

The number of poles is possible over the range [2, 400].

For more information, see the list of allowed combinations between the number of slots and the number of poles, synthesized in the section dedicated to winding.

Note: Our processes for building and computations have been qualified over the following data ranges:

Range for diameters [1, 1000] mm.

Range for number of slots [3, 90].

Range for number of poles [2, 80].

Working beyond these limits is possible but accurate results are the responsibility of the user.

## 1.3 Housing

### 1.3.1 Overview

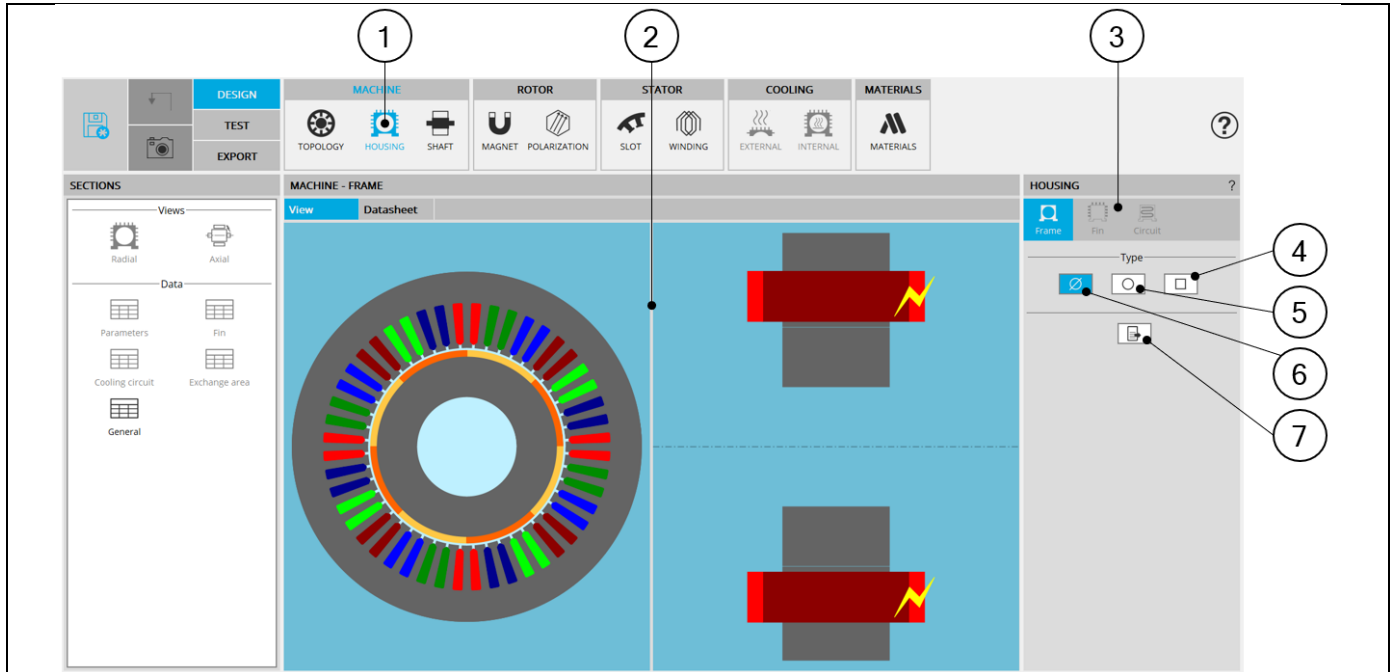

HOUSING design area

1	Selection of the MACHINE subset: HOUSING panel (Click on the icon HOUSING)
2	Radial and axial view of the motor.
3	Several sections allow defining all characteristics which are dealing with the Housing: Frame, Fin and Cooling circuit. Note: By default, the section Frame is selected.
4-5-6	Three choices are available to define the lamination topology: None, Circular and Square
4	Choice of a square shape lamination. See additional information below
5	Choice of a circular shape lamination. See additional information below
6	Choice of "None" meaning that the outer shape of lamination is circular without extensions. Outer dimensions of lamination are indicated in general data (structural data part).
7	Icon to export lamination data into *.txt or *.xlsx files.

### 1.3.2 Housing - Frame

#### 1.3.2.1 Type of frame

The tools available in the housing tab allow defining the frame topology. Three choices are available to define this topology: None, Circular or Square.

By default, housing type is set to “None”. There is no frame.

Important note: When “None” is selected, accesses to External cooling and Internal cooling environments are locked.

	1	Default setting : Housing type is « None » The machine has no frame.
	2	Button to select a Circular shape frame.
	3	Button to select a Square shape frame.
	4	Icon to export frame data into *.txt or *.xlsx files.
Frame type available		

Circular shape frame design area	
1	Radial view of the motor, including the housing topology and dimensions.
2	Axial view of the motor, including the housing topology and dimensions.
3	The section frame is selected to define the type and dimensions of the frame.
4	Selected button to set a circular shape frame.
5	User input parameters to define the frame dimensions. For more information see below.
6	Button to restore default input values.
7	Button to apply inputs. Pressing the enter key twice applies inputs too.
8	Icon to export frame data into *.txt or *.xlsx files.

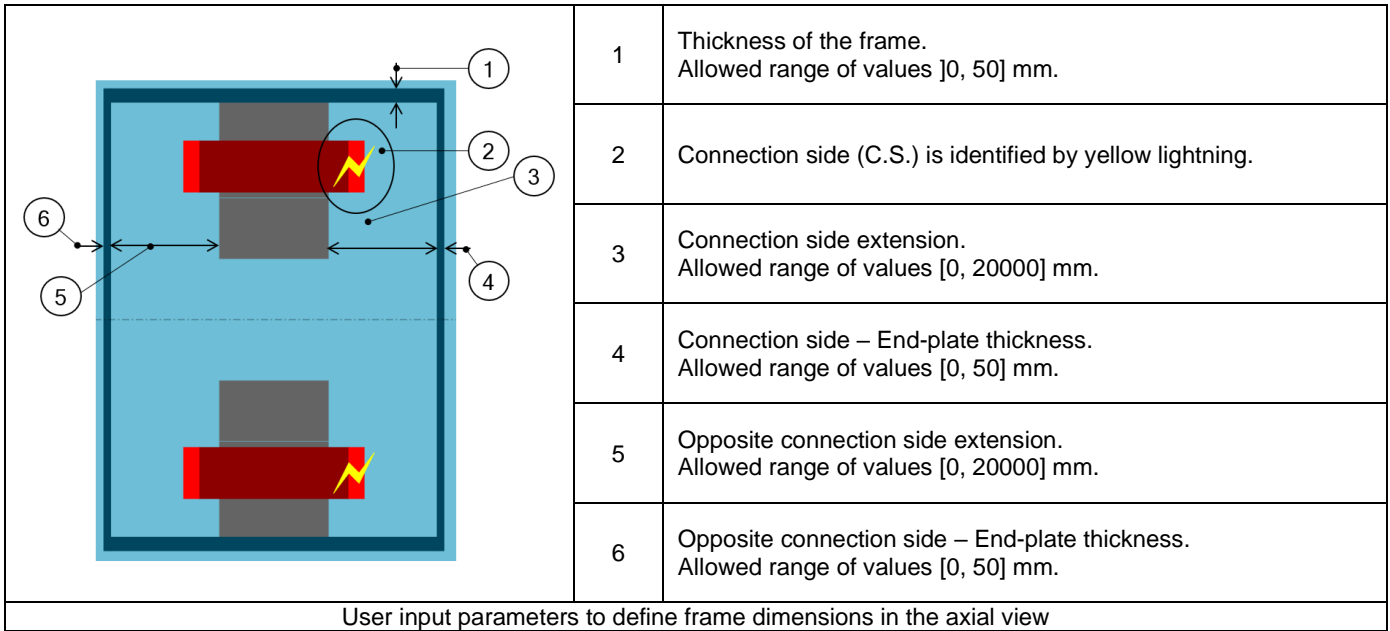

1.3.2.2 Combination between lamination outer shape and frame types

		Frame type		
		None	Circular	Square
Lamination outer shape	None	v	v	v
	Circular	v	v	v
	Square	v	Not possible	v

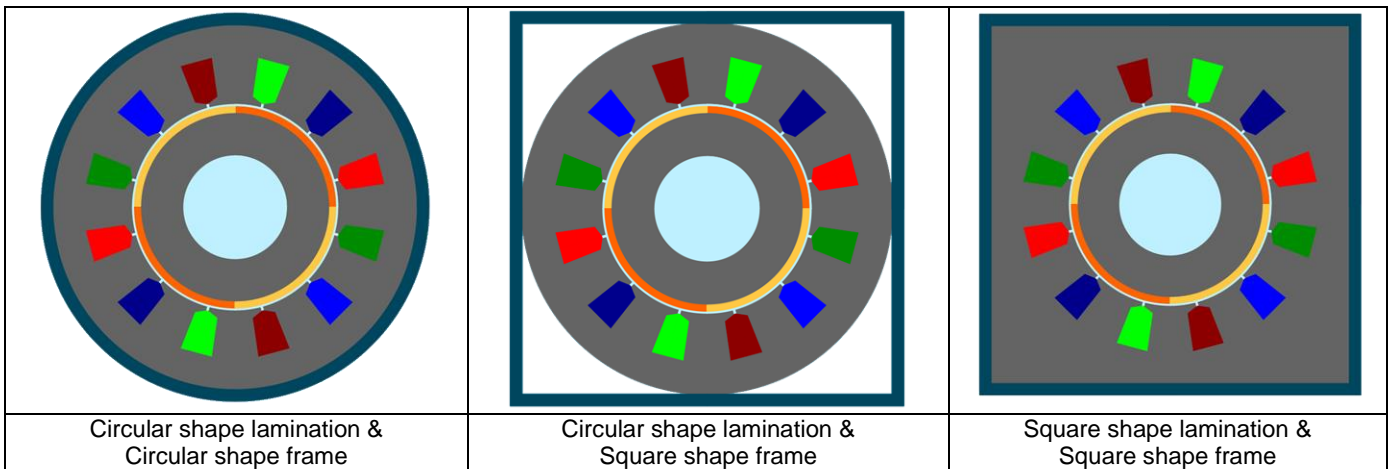



### 1.3.3 Housing – Fin

#### 1.3.3.1 Overview

Access to the “Fin” area is unlocked when a frame is defined, whose shape is circular or square.

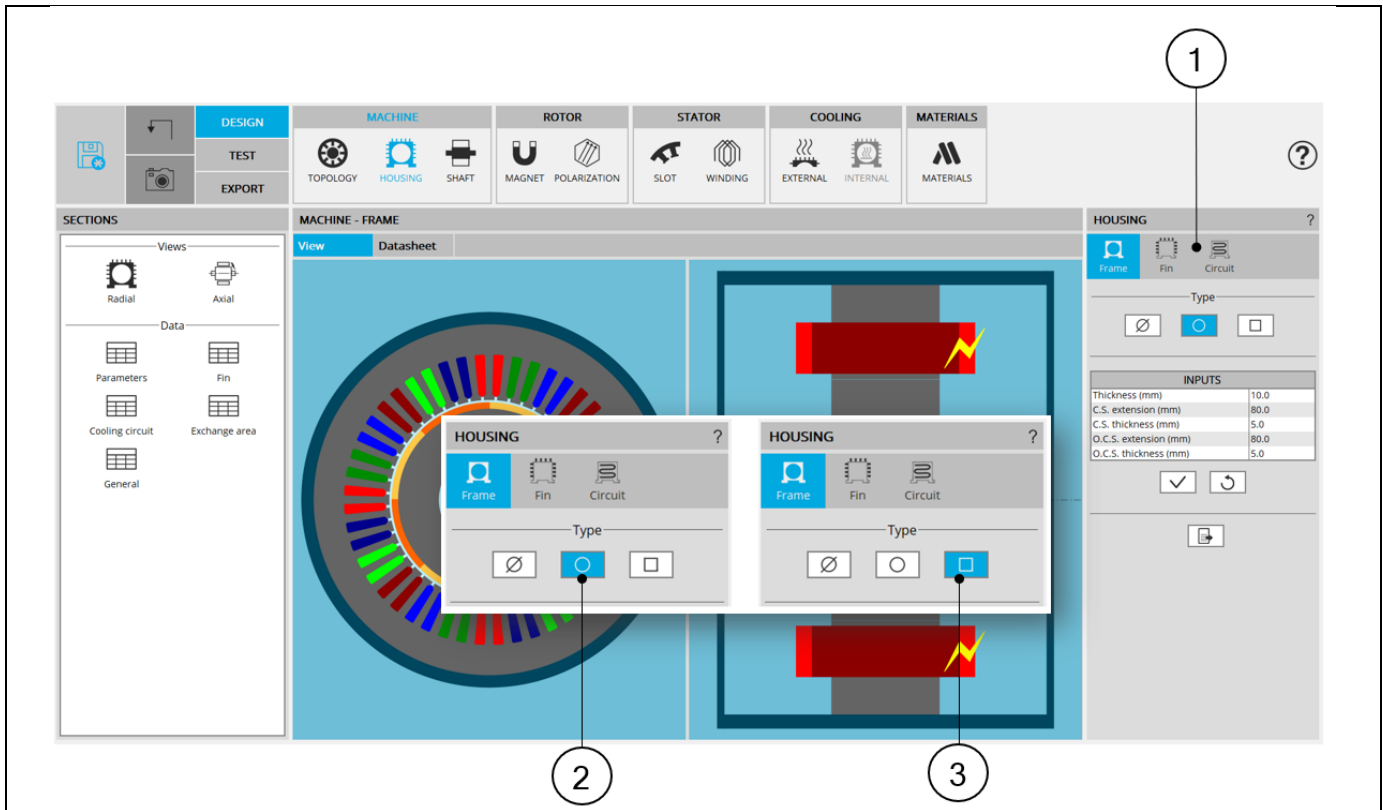

How to unlock the “Fin” area ?

1	“Fin” area is unlocked (as well as the “Cooling circuit” area).
2	Selection of a circular shape frame.
3	Selection of a square shape frame.

#### 1.3.3.2 Type of fins

The tools available in the housing tab allow defining the fin topology. Three choices are available to define this topology: None, Parallel or Radial.

By default, fin type is set to “None”. There is no fin.

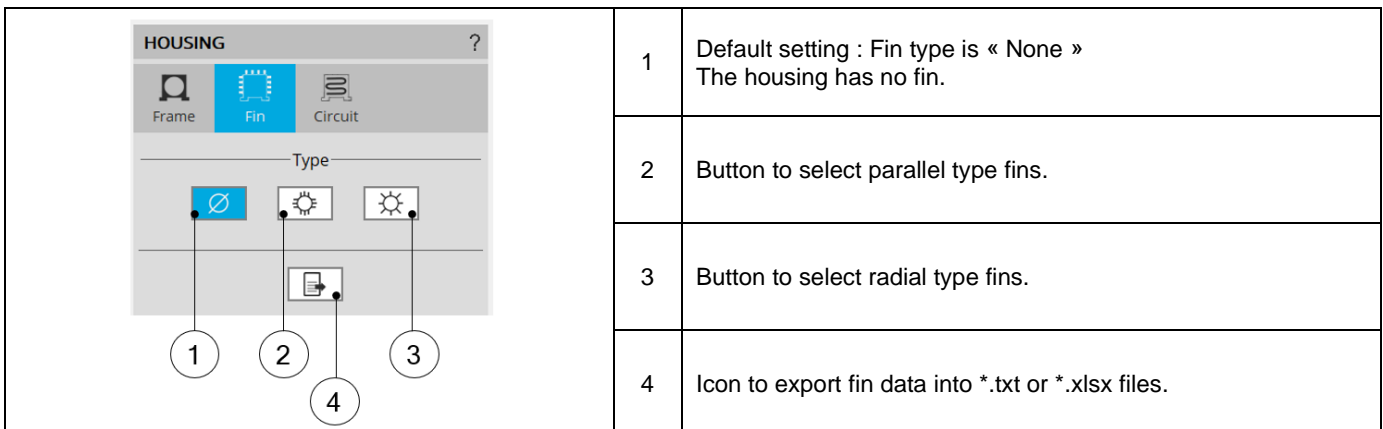

Fin type available

1.3.3.3 Parallel type fins – Topologies and dimensions

1) Parallel type fin area

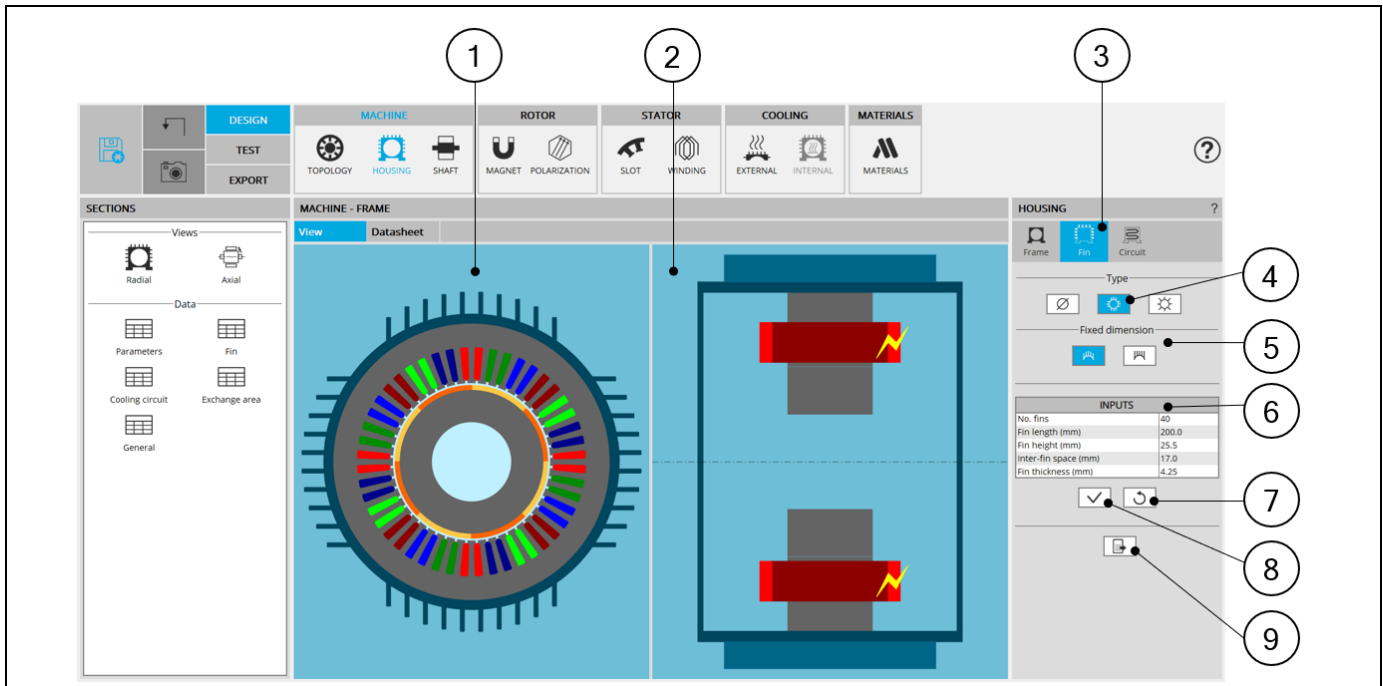

Parallel type fin design area

1	Radial view of the motor, including the housing topology with fin topology and dimensions.
2	Axial view of the motor, including the housing topology with fin topology and dimensions.
3	The section fin is selected to define the type and dimensions of the fins.
4	Selected button to define parallel type fins.
5	Two ways are possible to define the fin dimensions: "Height" and "Extension" options. See below illustrations.
6	User input parameters to define the fin dimensions. For more information see below.
7	Button to restore default input values.
8	Button to apply inputs. Pressing the enter key twice applies inputs too.
9	Icon to export frame data into *.txt or *.xlsx files.

2) Parallel type fins with constant height – Inputs

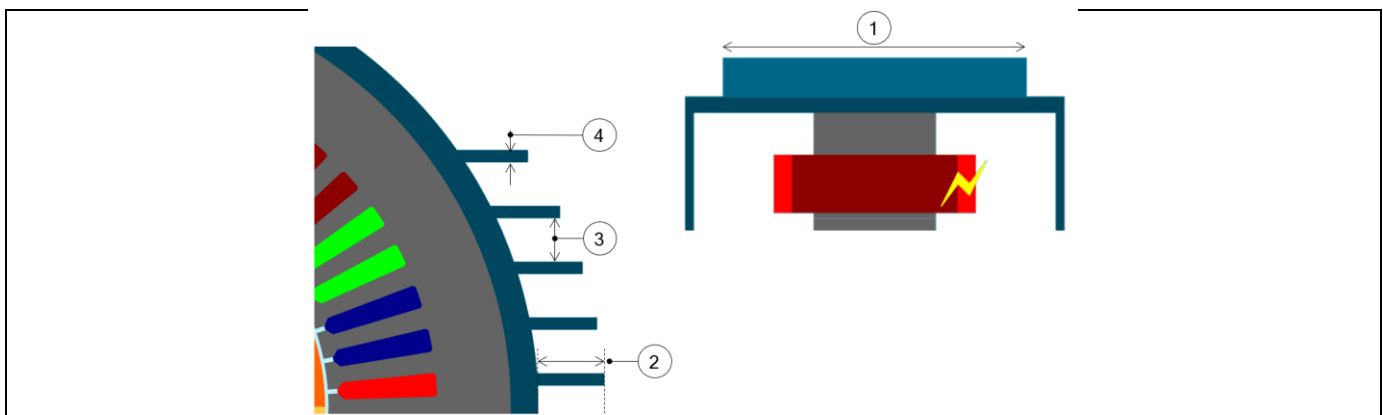

Parallel type fin with constant height - Inputs

#	No. fins (Number of fins) which spread all around the housing – Minimum allowed value = 12.
1	Fin length
2	Fin height
3	Inter-fin space
4	Fin thickness

3) Parallel type fins with constant total extension – Inputs

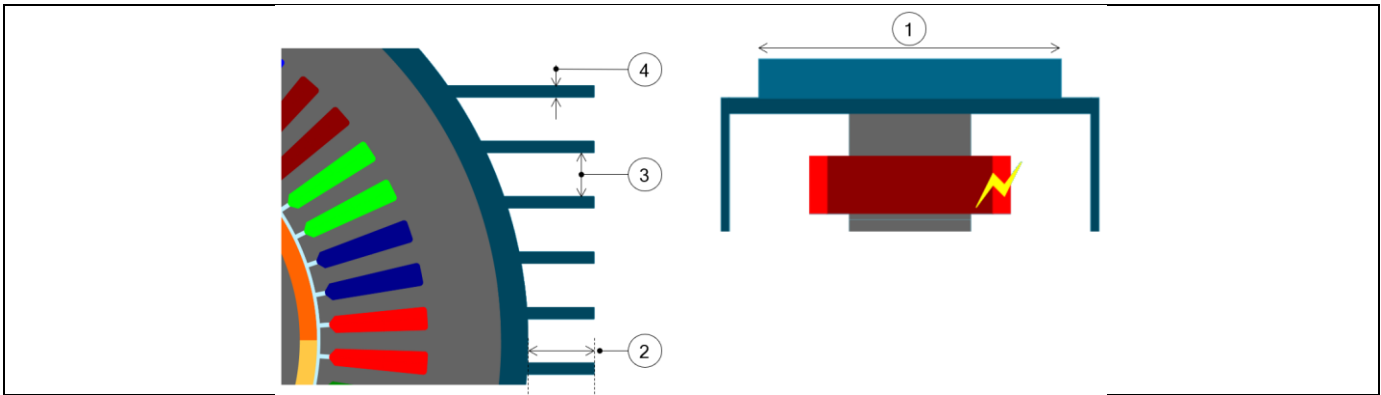

Parallel type fin with constant height - Inputs

#	No. fins (Number of fins) which spread all around the housing – Minimum allowed value = 12.
1	Fin length
2	Fin extension
3	Inter-fin space
4	Fin thickness

1.3.3.4 Radial type fins – Topologies and dimensions

1) Radial type fin area

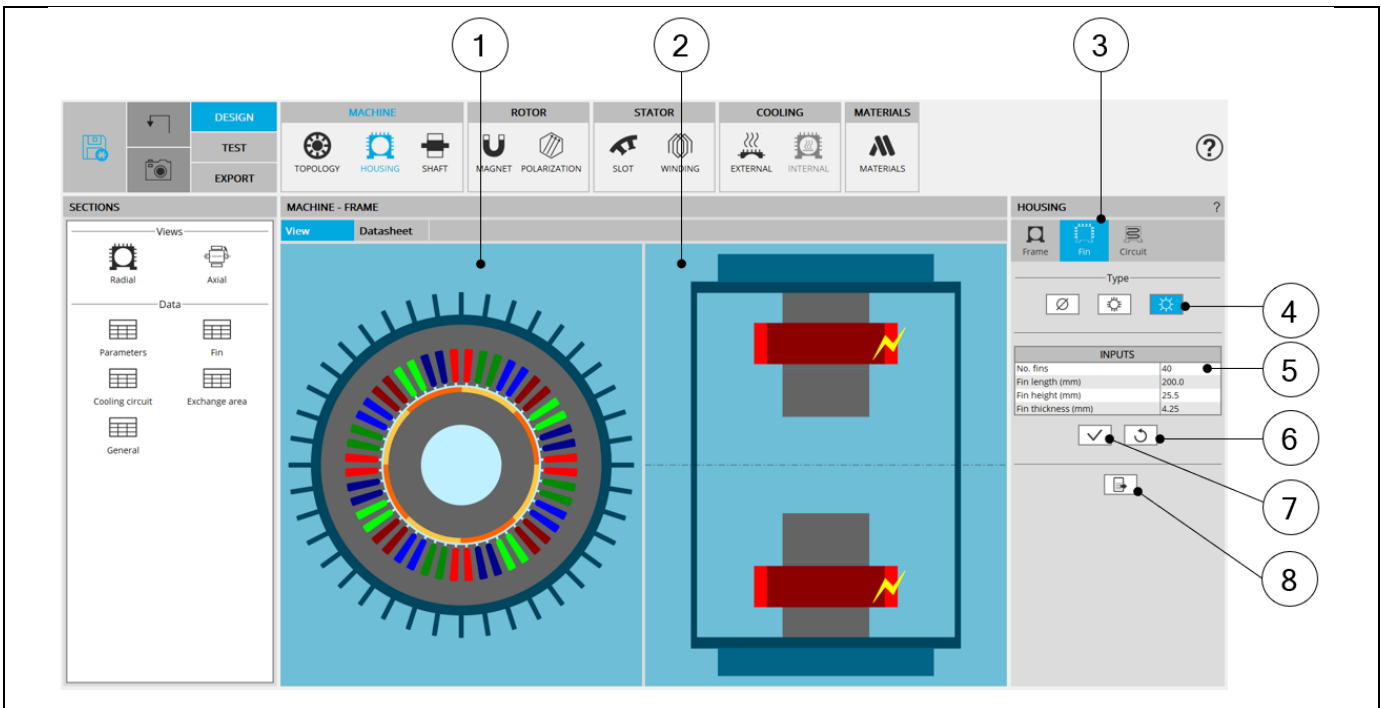

Radial type fin design area

1	Radial view of the motor, including the housing topology with fin topology and dimensions.
2	Axial view of the motor, including the housing topology with fin topology and dimensions.
3	The section fin is selected to define the type and dimensions of the fins.
4	Selected button to define radial type fins.
5	User input parameters to define the fin characteristics. For more information see below.
6	Button to restore default input values.
7	Button to apply inputs. Pressing the enter key twice applies inputs too.
8	Icon to export frame data into *.txt or *.xlsx files.

2) Radial type fins – Inputs

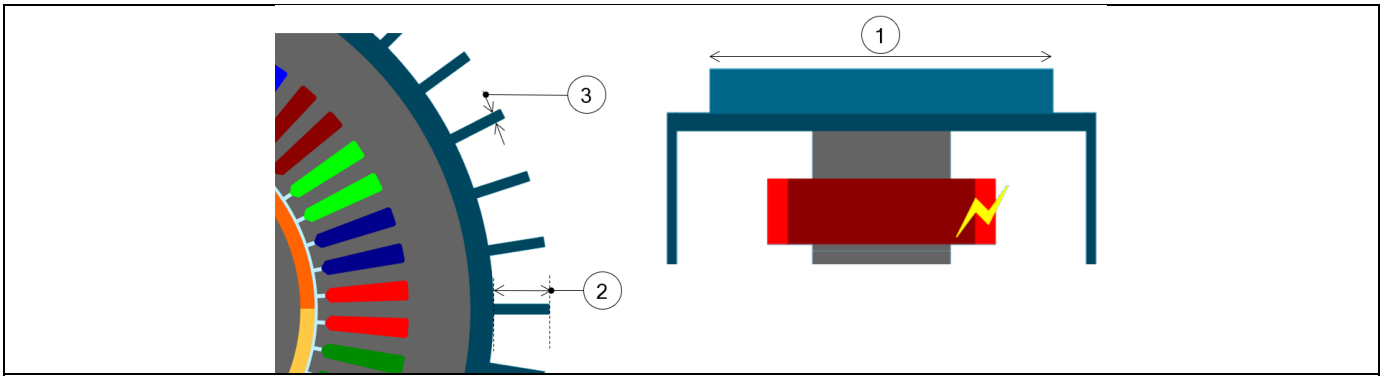

Parallel type fin with constant height - Inputs

#	No. fins (Number of fins) which spread all around the housing – Minimum allowed value = 12.
1	Fin length
2	Fin height
3	Fin thickness

### 1.3.4 Housing – Cooling circuit

#### 1.3.4.1 Overview

Access to the “Cooling circuit” area is unlocked when a frame is defined, when its shape is circular or square.

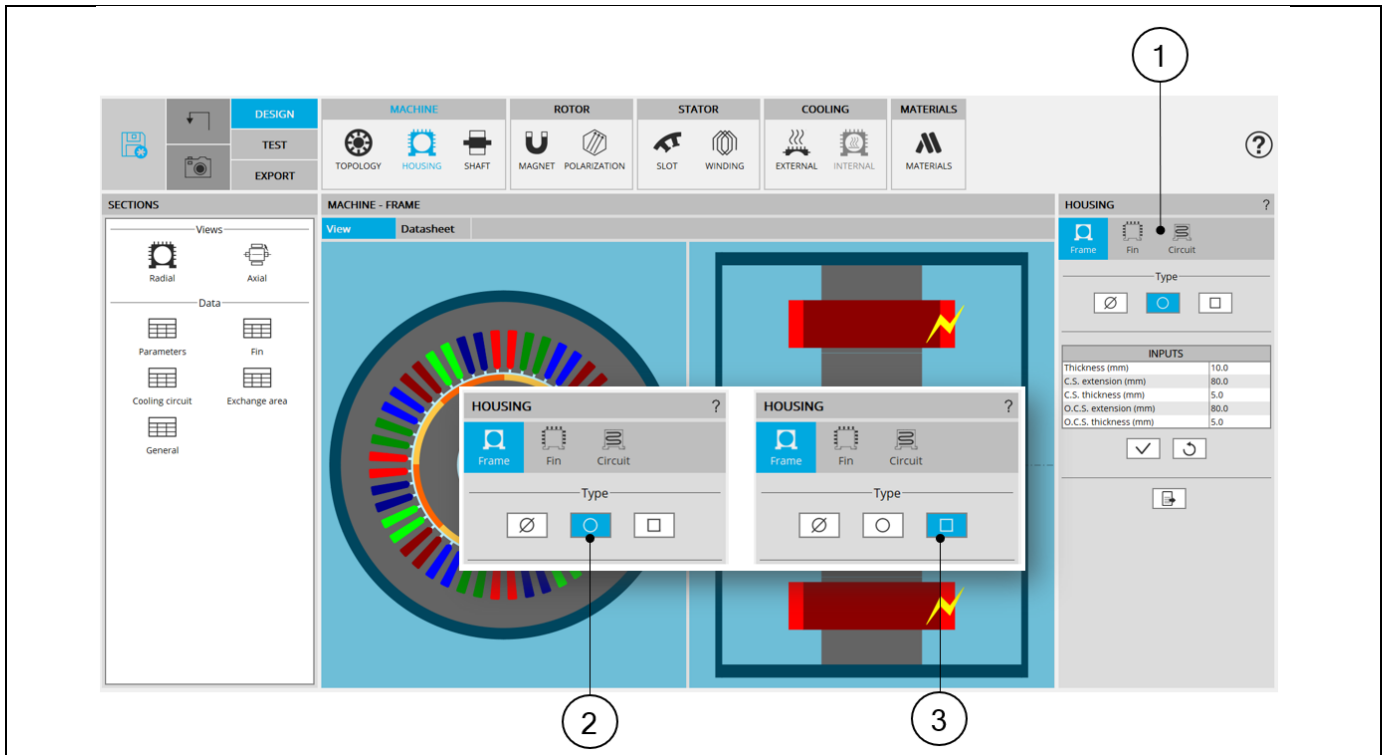

How to unlock the “Fin” area ?

1	“Fin” area is unlocked (as well as the “Cooling circuit” area).
2	Selection of a circular shape frame.
3	Selection of a square shape frame.

#### 1.3.4.2 Type of cooling circuits

The tools available in the housing tab allow defining the cooling circuit topology. Four choices are available to define this topology: None, Zig-Zag, solenoid or User shape.

By default, fin type is set to “None”. There is no cooling circuit.

	1	Default setting : Cooling circuit type is « None » There is no cooling circuit inside the housing.
	2	Button to select Zig-Zag type cooling circuit.
	3	Button to select Solenoid type cooling circuit.
	4	Button to select User type cooling circuit.
	5	Icon to export fin data into *.txt or *.xlsx files.

Cooling circuit type available

1.3.4.3 Cooling circuits – Topologies and dimensions

1) Zig-Zag type cooling circuit area

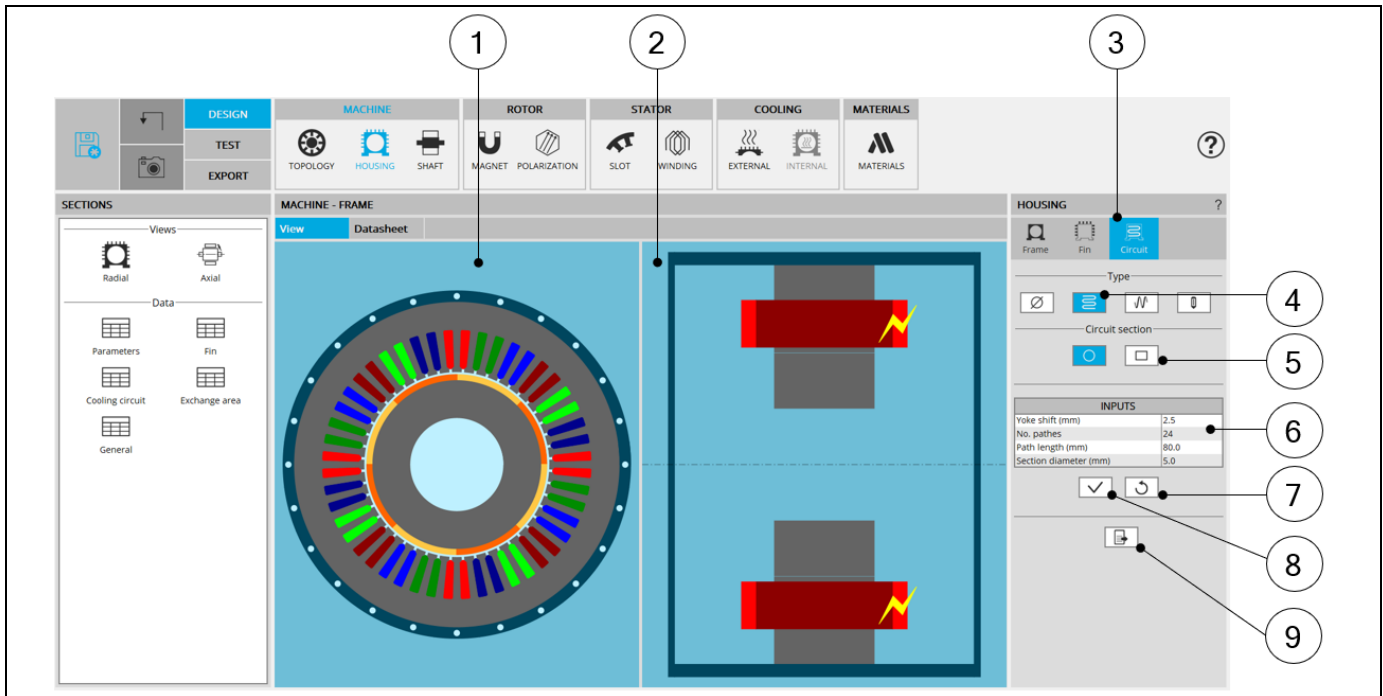

Zig-Zag type cooling circuit - Design area

1	Radial view of the motor, including the housing topology with cooling circuit topology and dimensions.
2	Axial view of the motor, including the housing topology with cooling circuit topology and dimensions.
3	The section Circuit (Cooling circuit) is selected to define the type and dimensions of the cooling circuit.
4	Selected button to define the topology of the cooling circuit.
5	Two sections can be considered: Circular (default one) and rectangular.
6	User input parameters to define the cooling circuit characteristics. For more information see below.
7	Button to restore default input values.
8	Button to apply inputs. Pressing the enter key twice applies inputs too.
9	Icon to export frame data into *.txt or *.xlsx files.

2) Zig-Zag shape cooling circuit topology with circular section tubes – Inputs

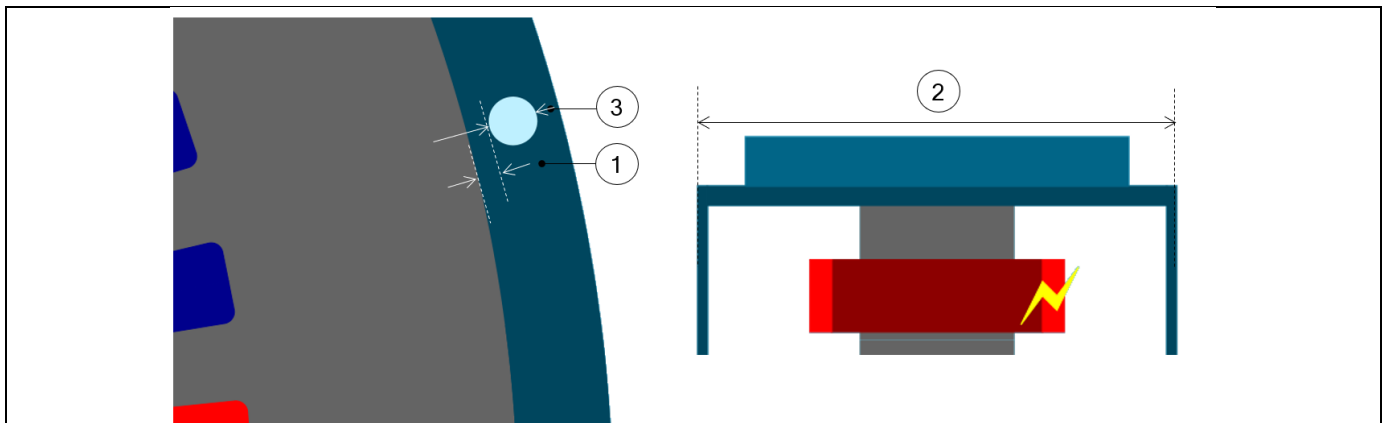

Zig-Zag shape cooling circuit – With circular tubes - Inputs

1	Yoke shift.
#	No. paths (Number of paths)
2	Path length in the axial direction
3	Section diameter

3) Zig-Zag shape cooling circuit topology with rectangular section tubes – Inputs

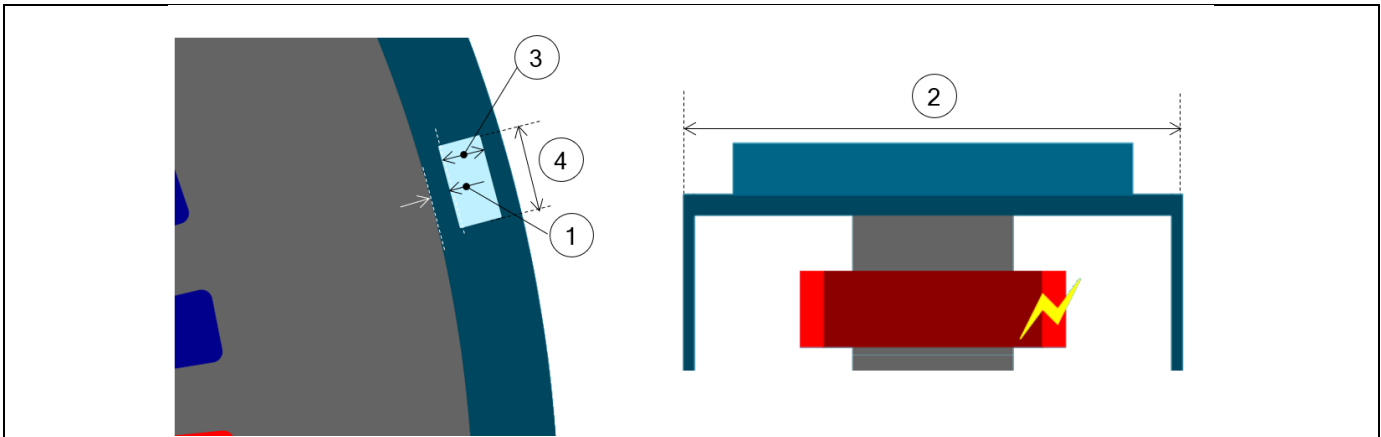

Zig-Zag shape cooling circuit – With rectangular tubes - Inputs

1	Yoke shift.
#	No. paths (Number of paths)
2	Path length in the axial direction
3	Section height
4	Section width

4) Solenoid type cooling circuit area

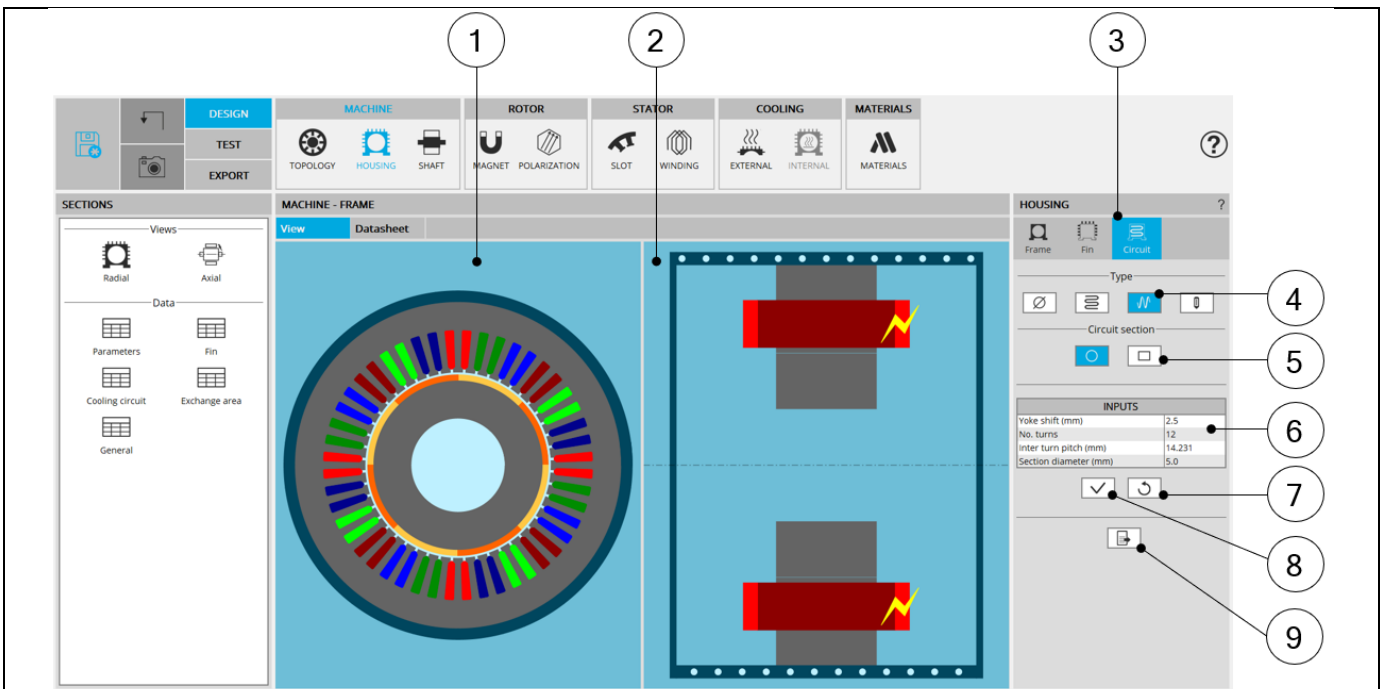

Solenoid type cooling circuit - Design area

1	Radial view of the motor, including the housing topology with cooling circuit topology and dimensions.
2	Axial view of the motor, including the housing topology with cooling circuit topology and dimensions.
3	The section Circuit (Cooling circuit) is selected to define the type and dimensions of the cooling circuit.
4	Selected button to define the topology of the cooling circuit.
5	Two sections can be considered: Circular (default one) and rectangular.
6	User input parameters to define the cooling circuit characteristics. For more information see below.
7	Button to restore default input values.
8	Button to apply inputs. Pressing the enter key twice applies inputs too.
9	Icon to export frame data into *.txt or *.xlsx files.

## 5) Solenoid shape cooling circuit topology with circular section tubes– Inputs

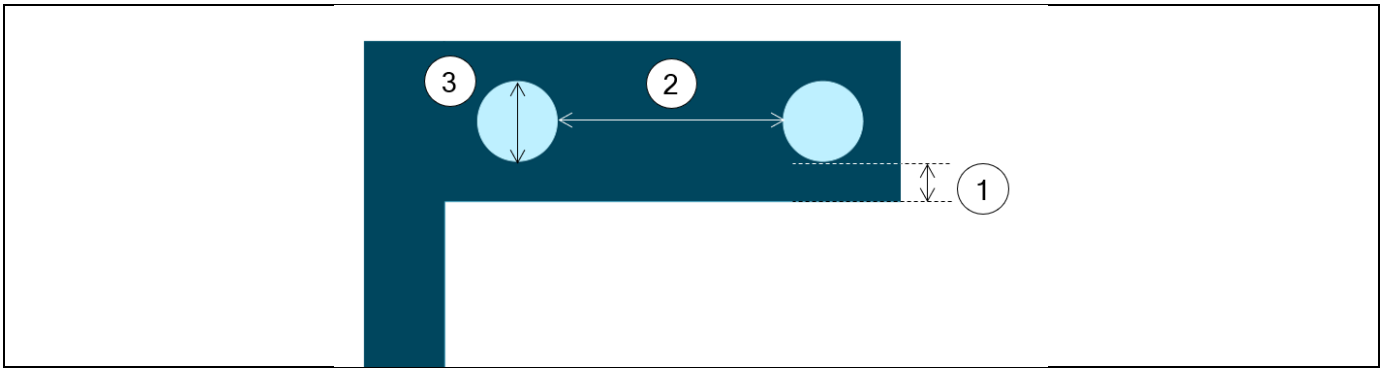

Solenoid shape cooling circuit – With circular tubes - Inputs

1	Yoke shift.
#	No. turns (Number of turns)
2	Inter turn pitch
3	Section diameter

## 6) Solenoid shape cooling circuit topology with rectangular section tubes– Inputs

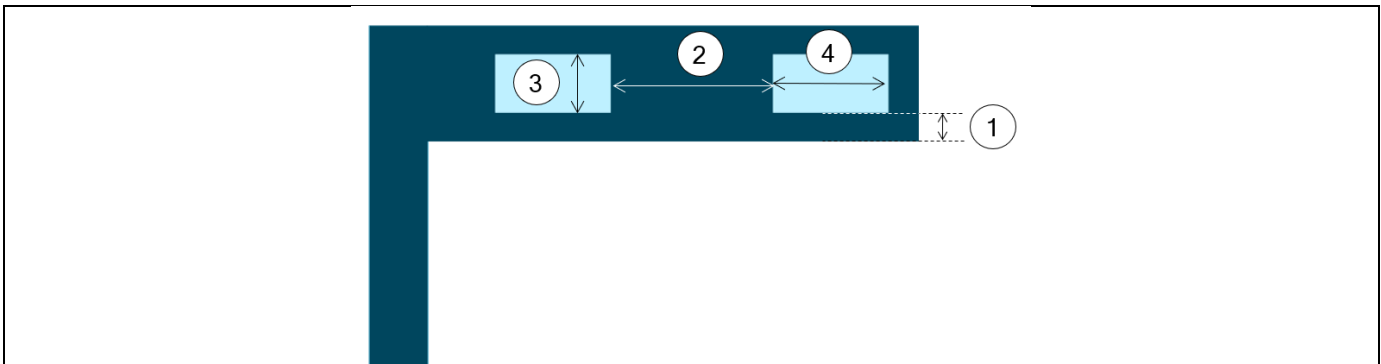

Solenoid shape cooling circuit – With rectangular tubes - Inputs

1	Yoke shift.
#	No. turns (Number of turns)
2	Inter turn pitch
3	Section height
4	Section width



## 7) User shape cooling circuit topology with circular section tubes – Inputs

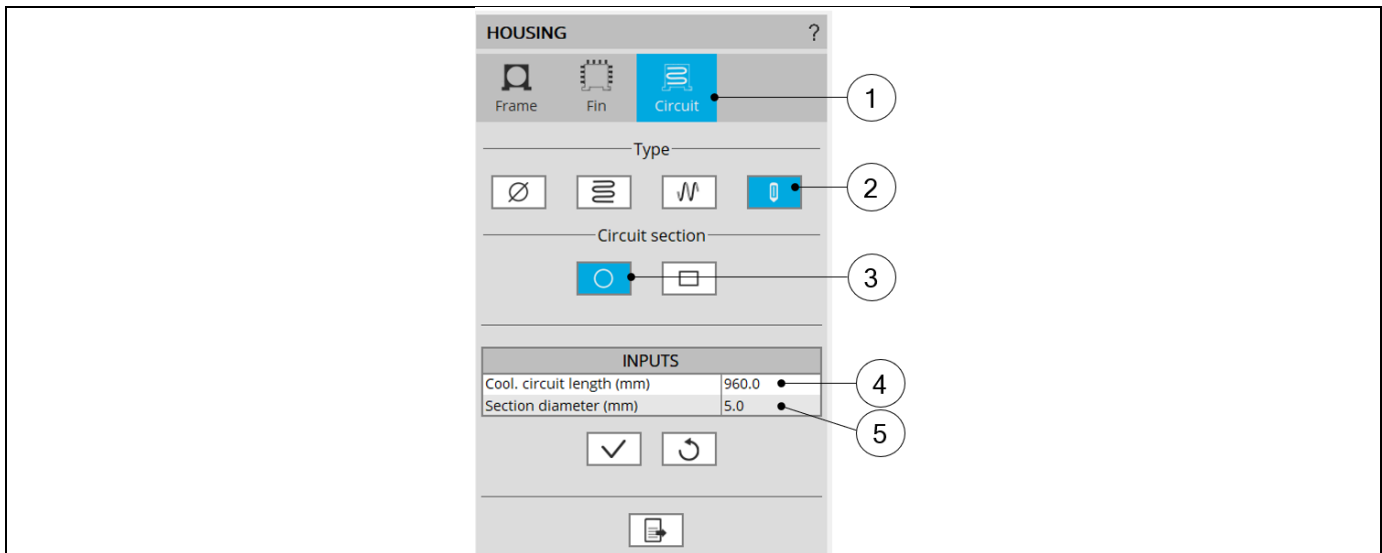

Solenoid shape cooling circuit – With rectangular tubes - Inputs

1	The section Circuit (Cooling circuit) is selected to define the type and dimensions of the cooling circuit.
2	Selected button to define the topology of the cooling circuit.
3	Two sections can be considered: Circular (default one) and rectangular.
4	Cooling circuit length.
5	Section diameter of cooling circuit tubes.

## 8) User shape cooling circuit topology with rectangular section tubes – Inputs

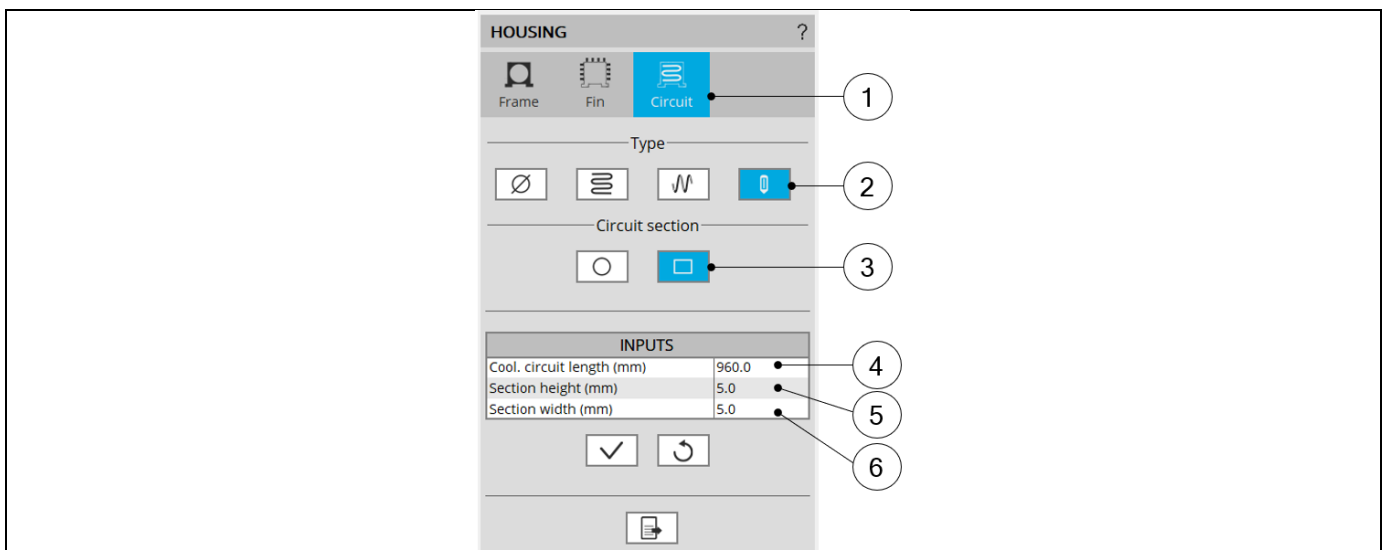

Solenoid shape cooling circuit – With rectangular tubes - Inputs

1	The section Circuit (Cooling circuit) is selected to define the type and dimensions of the cooling circuit.
2	Selected button to define the topology of the cooling circuit.
3	Two sections can be considered: Circular (default one) and rectangular.
4	Cooling circuit length.
5	Section height of cooling circuit tube.
6	Section width of cooling circuit tube.

# 1.4 Shaft

## 1.4.1 Overview

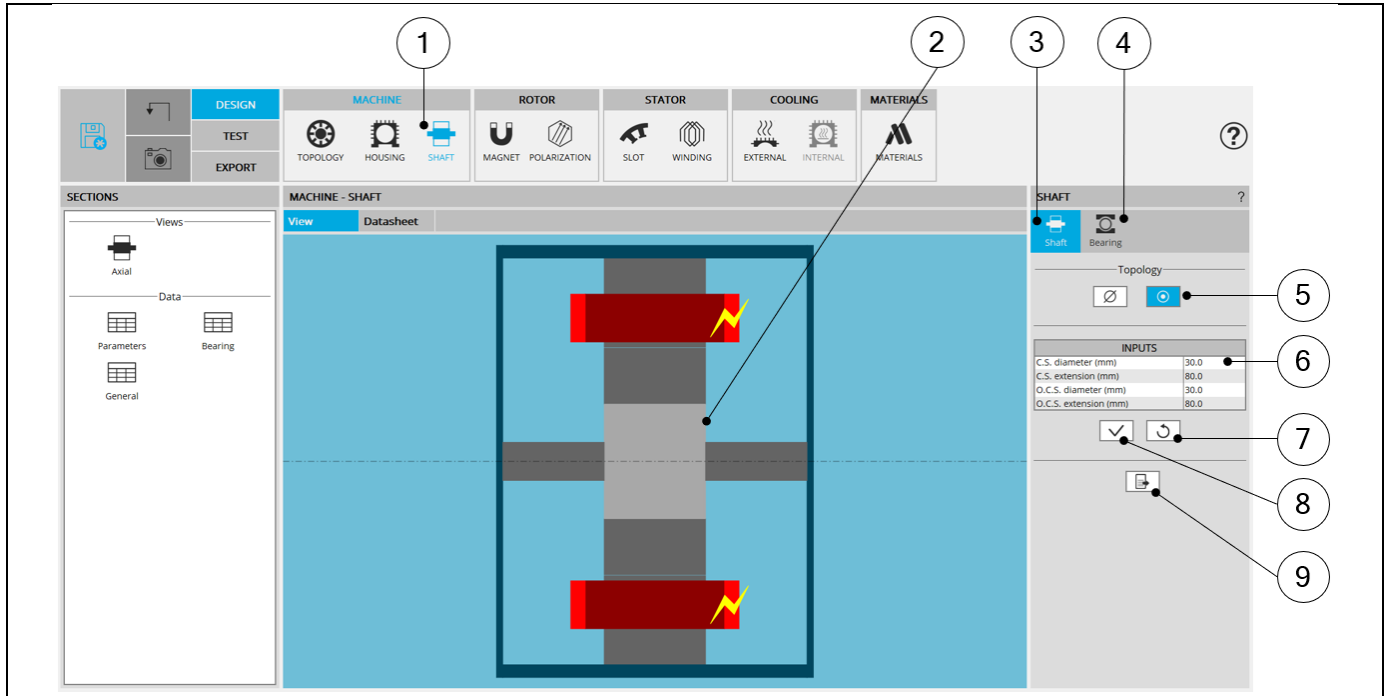

SHAFT design area

1	Selection of the MACHINE subset: SHAFT panel (Click on the icon SHAFT)
2	Visualization of the motor axial view to visualize the shaft topology and dimensions.
3	Shaft section to define the shaft parameters
4	When there is a shaft, the section of Bearing is unlocked
5	Choice of the shaft type. Two types are available: <ul style="list-style-type: none"> <li>• None: No dimension to declare. Shaft is replaced by fluid material</li> <li>• Solid: End-shaft must be defined - Structural data of the shaft are then edited</li> </ul> If shaft type is solid, end-shaft must be defined. Note 1: Connection side (C.S.) is identified by yellow lightning. Note 2: Range of definition for dimensions: [0, 20000] mm.
6	Shaft input data to be defined
7	Button to restore default input values
8	Button to Apply inputs. Pressing the enter key twice applies inputs too.
9	Icon to export shaft data into *.txt or *.xlsx files.

## 1.4.2 Shaft type

Two types of shaft can be selected:

- None: A shaft is not represented in the rotor design. It is replaced by a fluid (like air)
- Solid: Shaft is represented and considered in the rotor design. It is built with a solid material or laminations

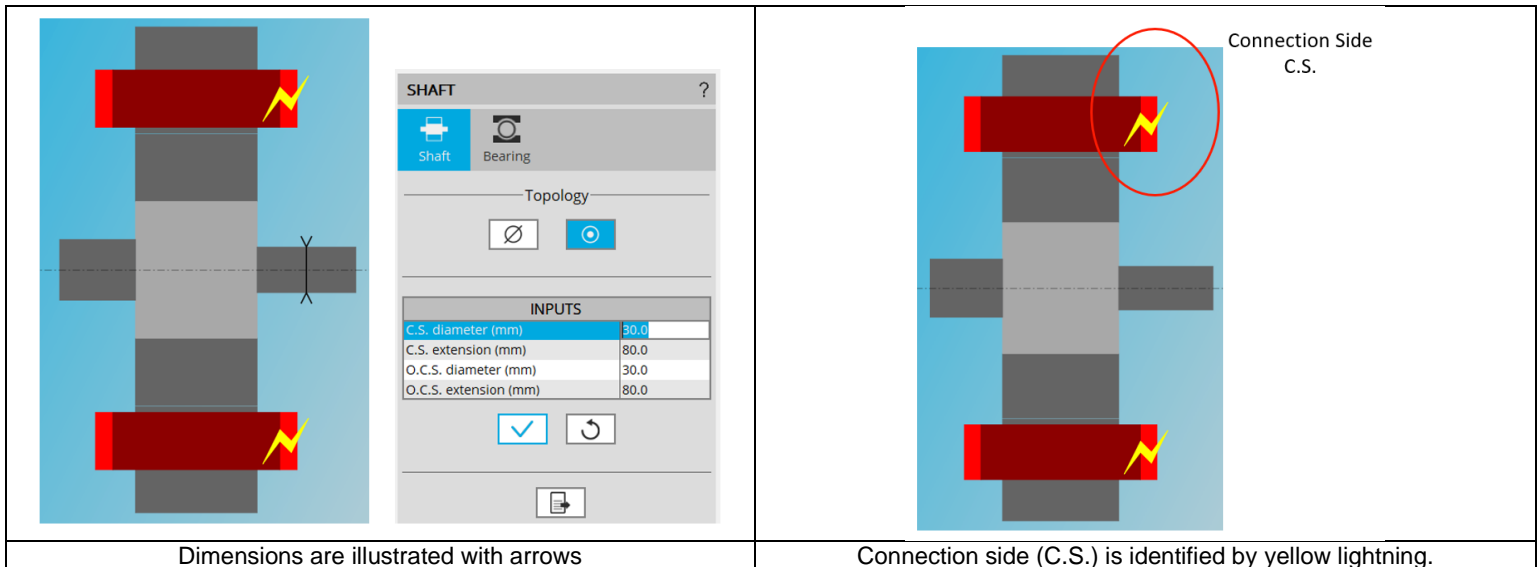
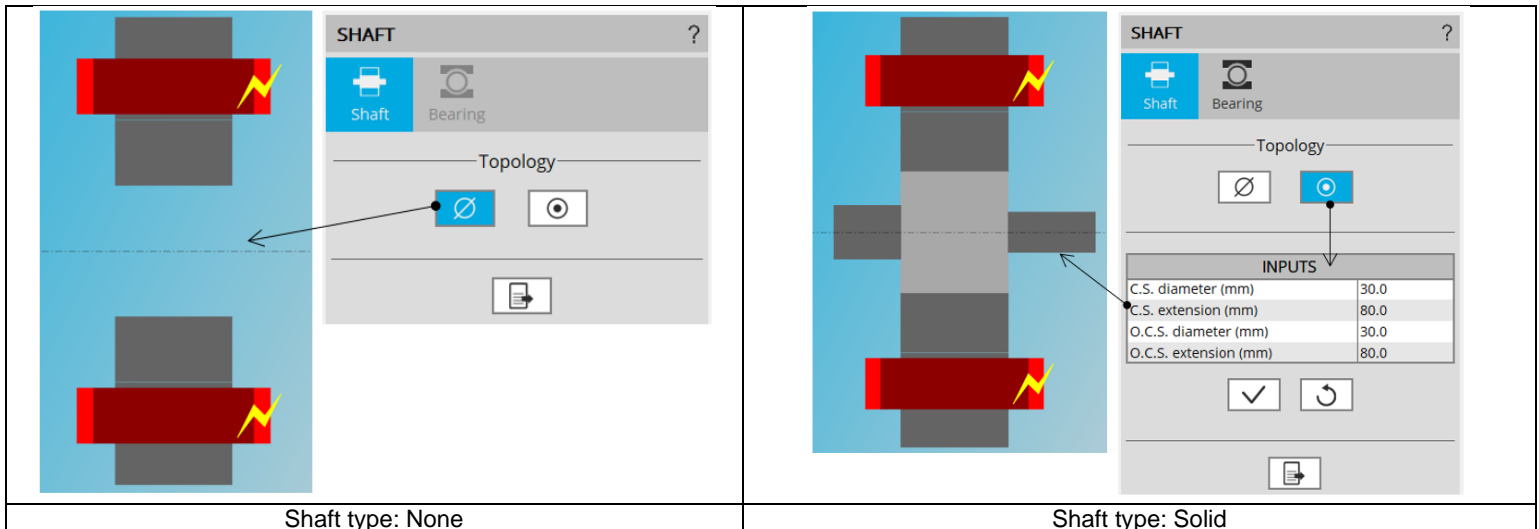

## 1.4.3 Shaft - Inputs

Label	Symbol	Tooltip, note, formula
C.S. diameter	D1	Connection side end-shaft diameter.
C.S. extension	L1	Connection side end-shaft extension.
O.C.S. diameter	D2	Opposite connection side end-shaft diameter.
O.C.S. extension	L2	Opposite connection side end-shaft extension.

## 1.4.4 Shaft – Bearing

## 1.4.4.1 Overview

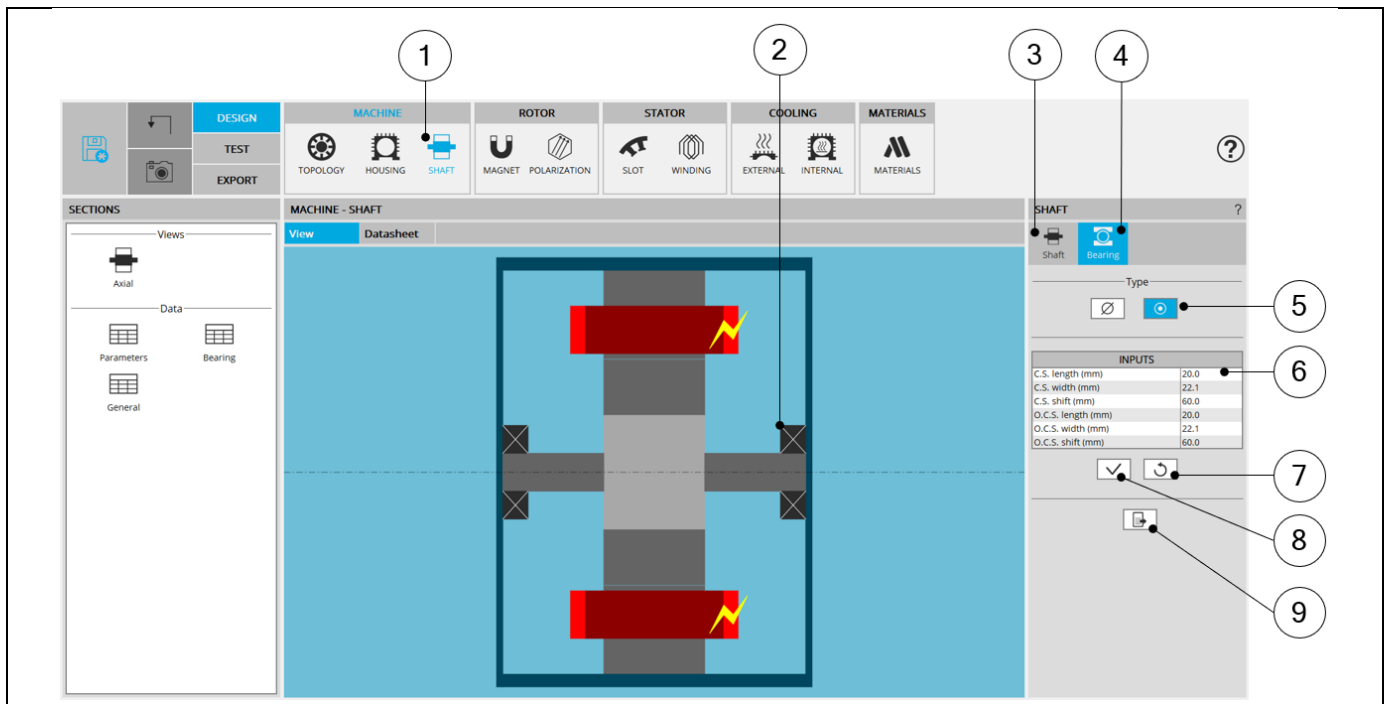

SHAFT – Bearing - Design area

1	Selection of the MACHINE subset: SHAFT panel (Click on the icon SHAFT)
2	Visualization of the motor axial view to visualize the shaft topology with bearings
3	Shaft section to define the shaft parameters
4	When there is a shaft, the section of Bearing is unlocked
5	Choice of the shaft-Bearing type. Two types are available: <ul style="list-style-type: none"> <li>• None: No dimension to declare. There is no bearing.</li> <li>• With bearings: Bearings characteristics must be defined - Structural data of bearings are then edited</li> </ul>
6	Shaft-Bearing input data to be defined
7	Button to restore default input values
8	Button to Apply inputs. Pressing the enter key twice applies inputs too.
9	Icon to export shaft data into *.txt or *.xlsx files.

Important note: When “None” is selected, accesses to Internal cooling environment is locked.

1.4.4.2 Shaft-Bearing type and characteristics

Two types of shaft can be selected:

- None: There is no bearing in the rotor design = No dimension to declare.
- With bearings: Shaft-Bearings are represented and considered in the rotor design.

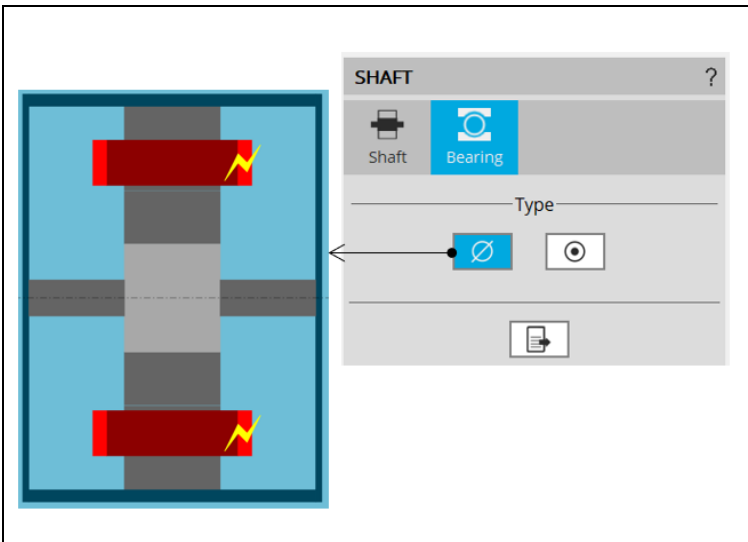

Shaft-Bearing type: None

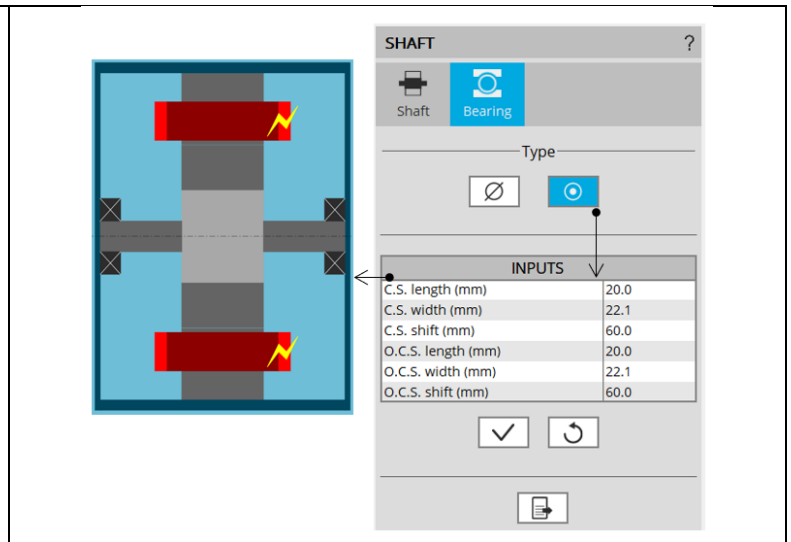

Shaft-Bearing type: With bearings

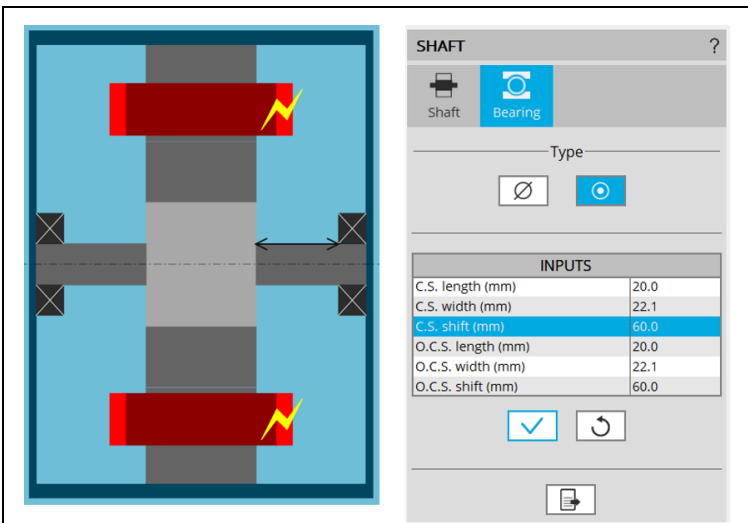

Dimensions are illustrated with arrows

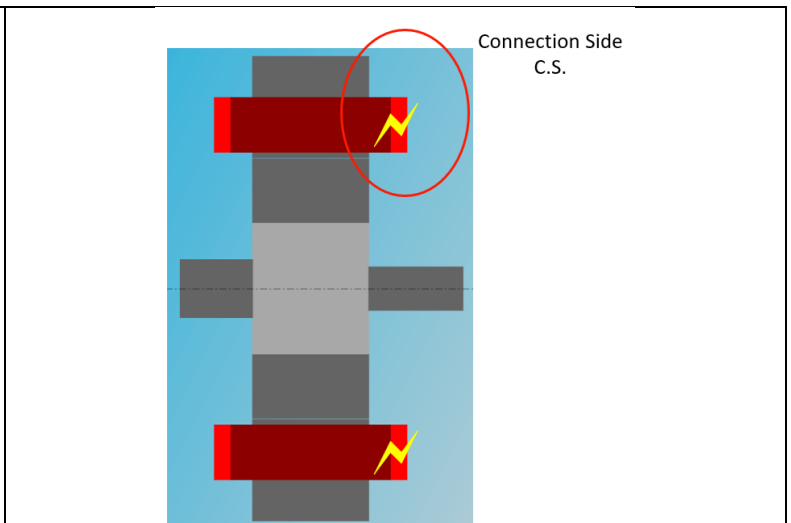

Connection side (C.S.) is identified by yellow lightning.

## 1.4.4.3 Shaft-Bearing input parameters

Label	Tooltip, note, formula
C.S. length	Connection side bearing length.
C.S. width	Connection side bearing width.
C.S. shift	Connection side bearing shift.
O.C.S. length	Opposite Connection side bearing length.
O.C.S. width	Opposite Connection side bearing width.
O.C.S. shift	Opposite Connection side bearing shift.

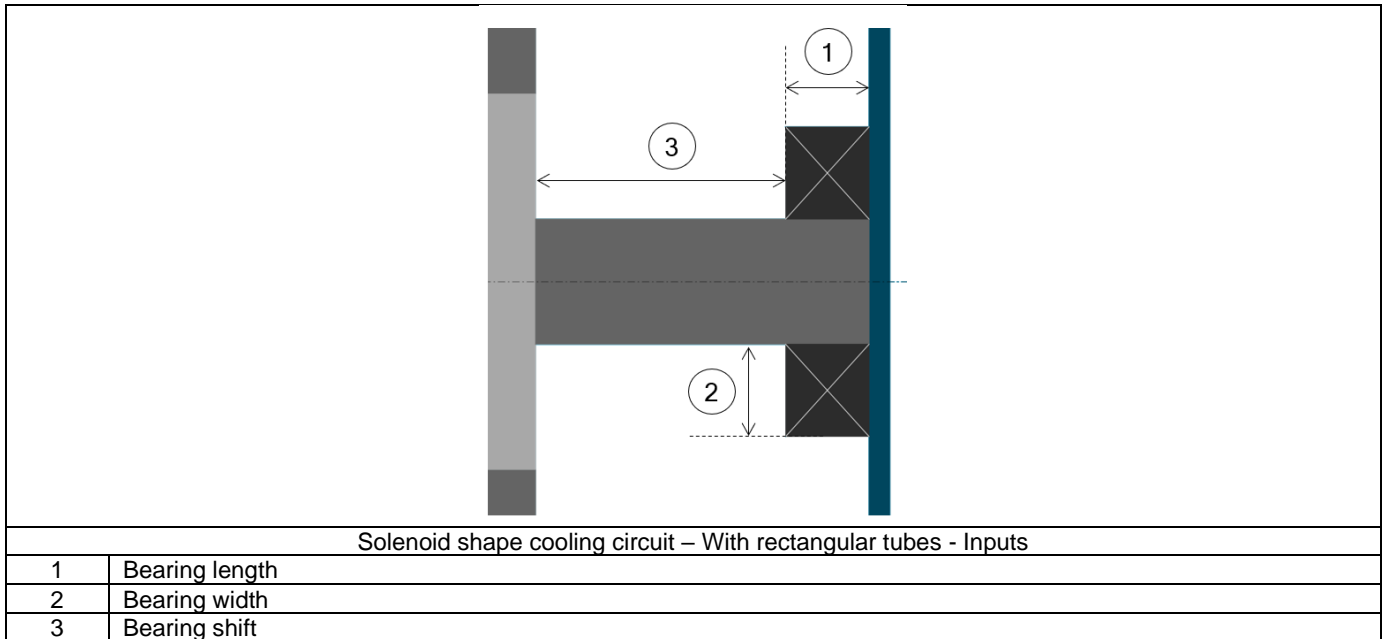

## 1.5 Magnet

### 1.5.1 Overview

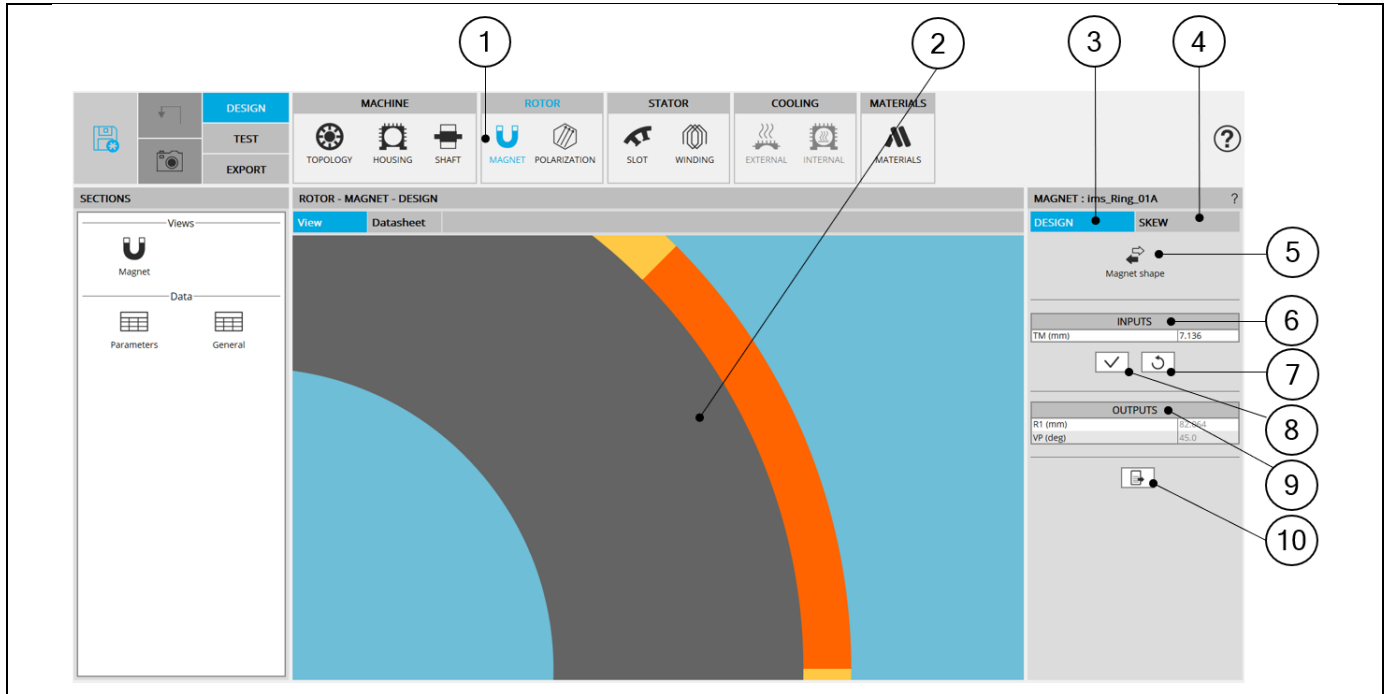

MAGNET design area

1	Selection of the ROTOR subset: MAGNET panel (Click on the icon MAGNET)
2	Visualization of the motor radial view to view the magnet topology and dimensions.
3	DESIGN tab indicates the tools to define the magnet topology and parameter values Note: By default, DESIGN tab is selected
4	SKEW tab indicates the tools to define the rotor (magnet) skew angle
5	"Magnet shape" button allows accessing the magnet libraries to change the magnet topology. See additional information below.
6	User input parameter fields to enter the values.
7	Button to restore default input values.
8	Button to apply inputs. Pressing the "enter key" twice applies inputs too.
9	Output parameters (read only data) to complete the description of the topology.
10	Icon to export magnet data into *.txt or *.xlsx files.

## 1.6 Magnet design

### 1.6.1 Choose a magnet topology

Clicking on the "Magnet shape" button opens a dialog box, allowing to access the magnet libraries. It allows visualizing, comparing, choosing, and importing another magnet topology to modify in the current rotor design.

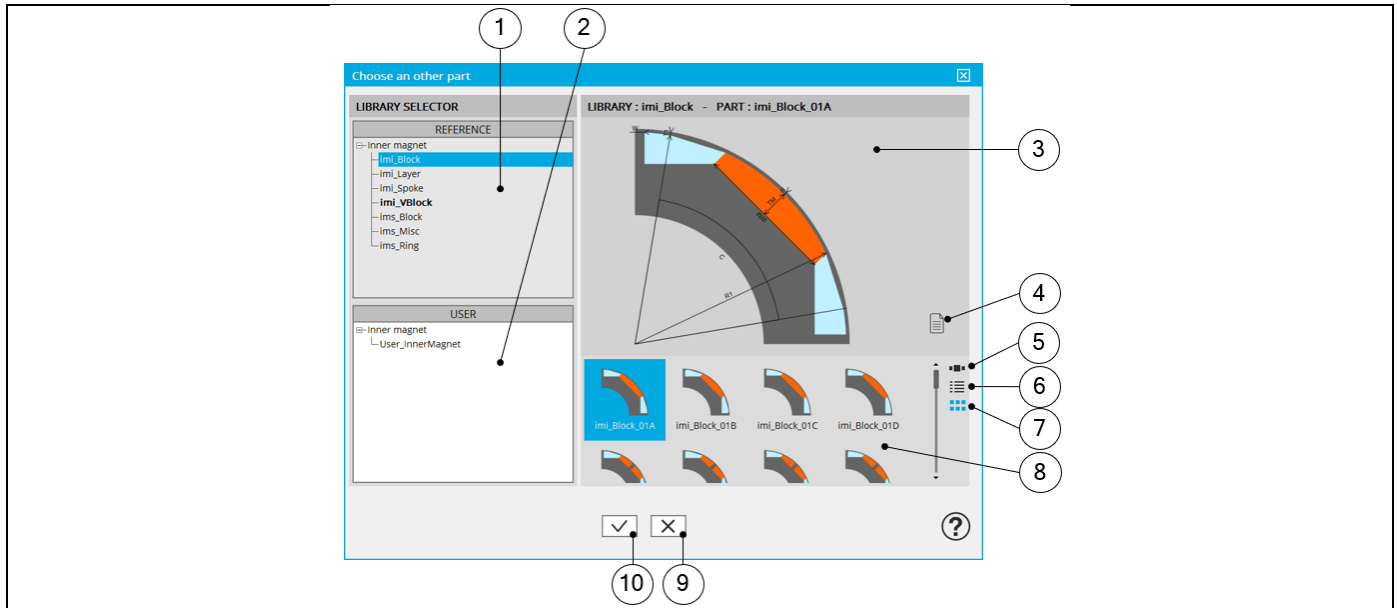

How to choose another magnet topology?

1	Visualization of reference libraries i.e. the libraries of magnet's topologies provided with Altair® FluxMotor®. Select them to view their content and choose the magnet among their content. See "Part Library" application for more information.
2	Visualization of user libraries. The default user library is "User_InnerMagnet". See "Part Library" application for more information.
3	Area where the selected magnet is displayed (static picture) – Topology + dimension labels.
4	Button to visualize the list of documents attached to the part. See additional information below.
5	Button to display thumbnails as a slide show.
6	Button to display thumbnails as a list.
7	Button to display thumbnails as a matrix view of pictures.
8	Area to visualize all the topologies of magnets from the selected library (ref. 1).
9	Button to close the dialog box and come back to Motor Factory – DESIGN – Magnet area.
10	Button to choose and import the selected magnet to modify the current rotor design.

#### 1.6.1.1 Attached documents – Additional information

	1	List of attached documents displays after clicking on button to display it (4).
	2	"+" or "-" "non-active buttons from "Motor Factory" See "Part Library" application for more information.
	3	List of attached documents (if it exists) A double click on the selected document opens it. Documents can be added only from Part Library application. See "Part Library" application for more information.
	4	Button to show or to hide the attached document list.
Visualization of attached documents		



1.6.1.2 Inputs / Outputs

Specific inputs and outputs are considered for magnet topology. The relevance of input parameter values can be evaluated by using “Part Factory” application. See “Part Factory” application for more information.

Outputs are read only data. They complete the description of the topology.

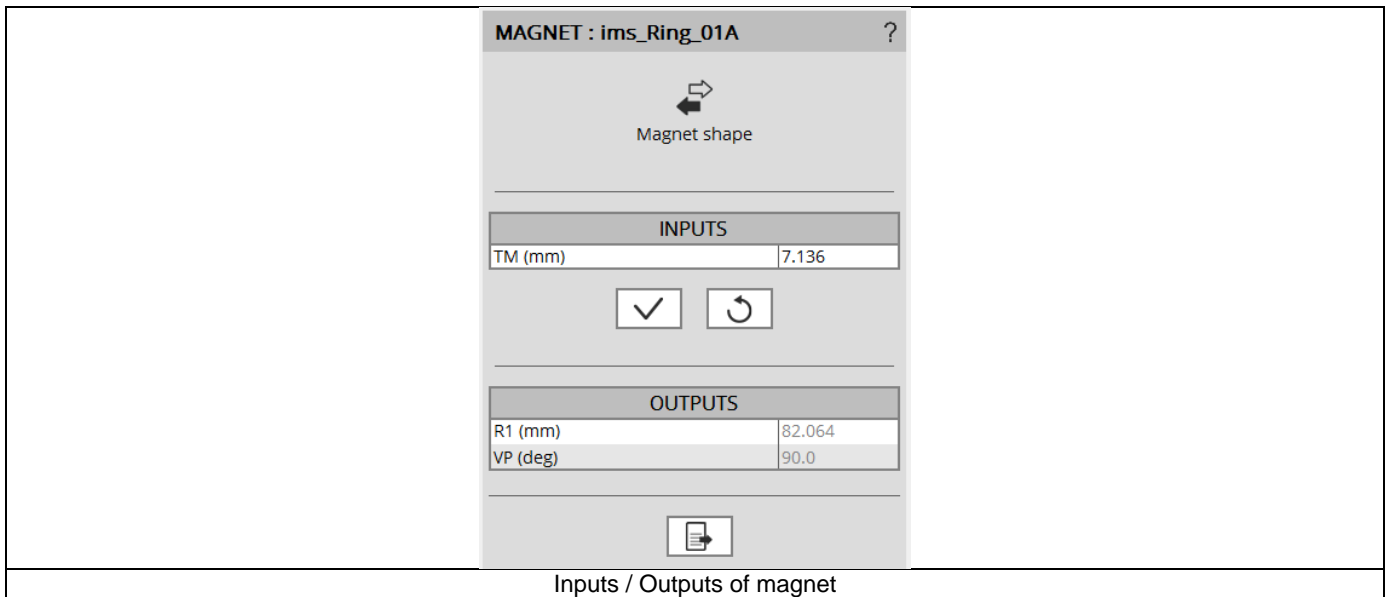

Inputs / Outputs of magnet

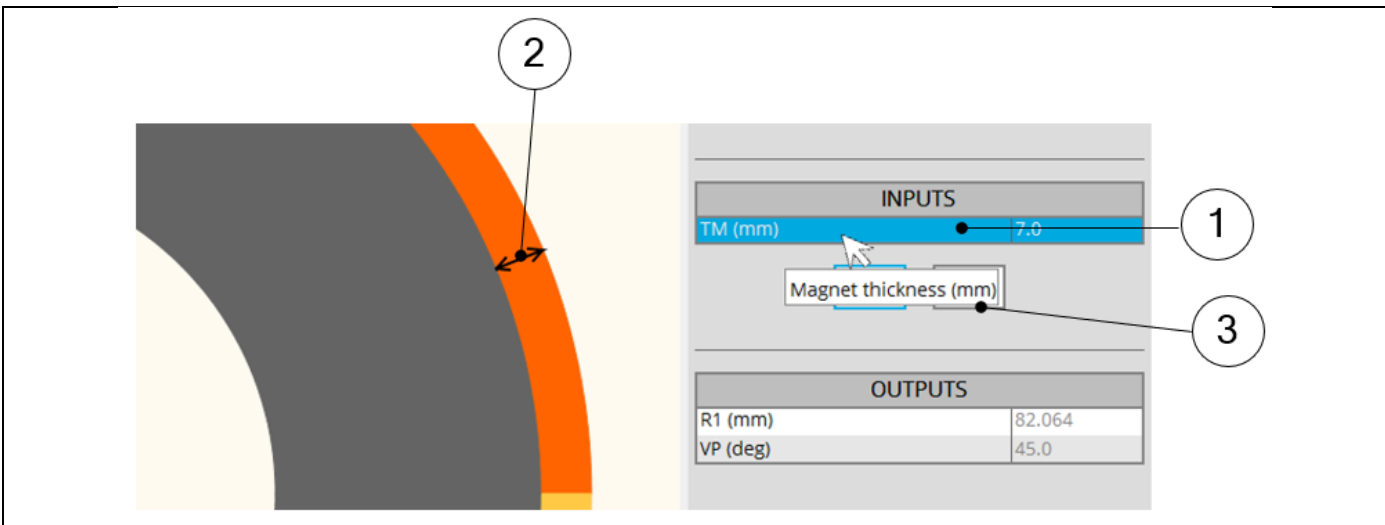

Inputs / Outputs of magnet

1	Selection of a parameter label highlights it.
2	Selection of a parameter label displays the corresponding arrow on the picture.
3	Selection of a parameter label displays the corresponding tooltip which completes information about the parameter.

## 1.6.2 Magnet – Skew

## 1.6.2.1 Overview

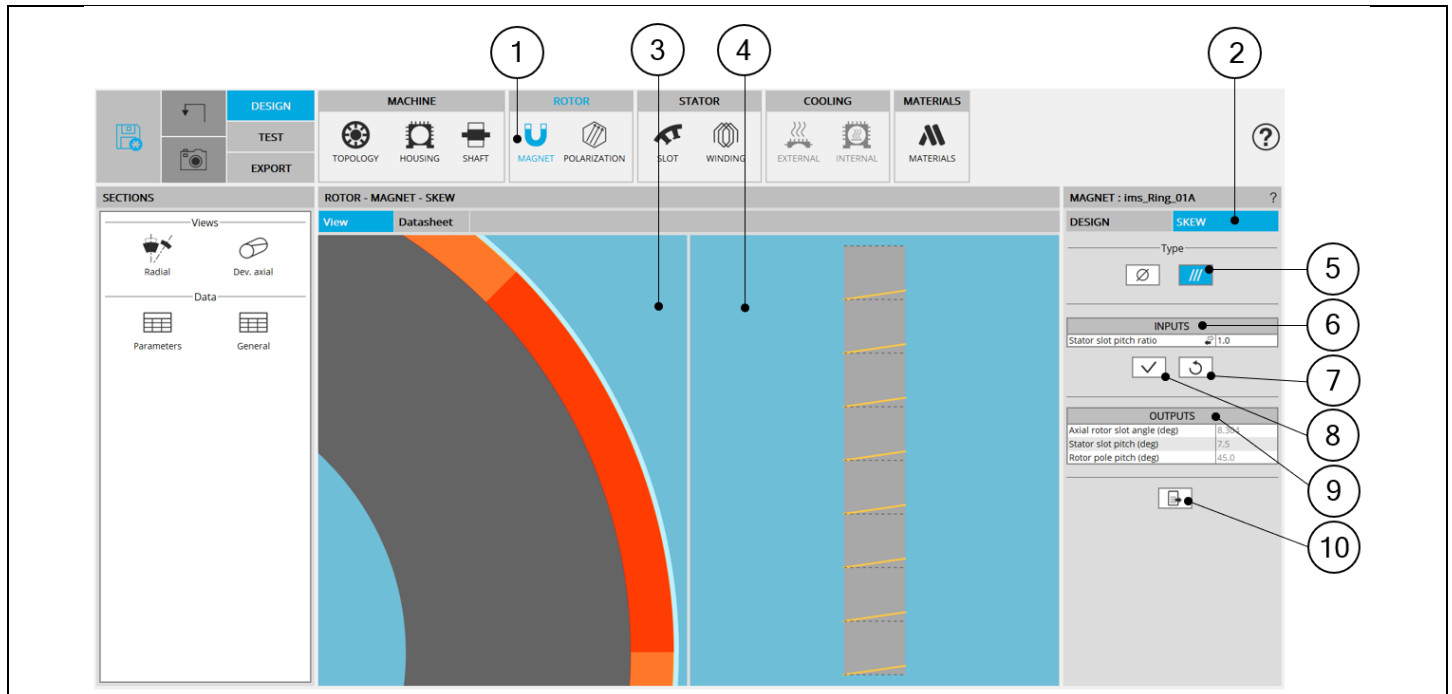

## BAR – SKEW design area

1	Selection of the ROTOR subset: MAGNET panel (Click on the icon MAGNET)
2	SKEW tab indicates the tools to define the rotor (magnet) skewing angle
3	Visualization of the motor radial view with bar topology and dimensions.
4	Visualization of the rotor developed view to visualize the rotor (magnet) skewing
5	Choices to define a skew: None – Continuous (Continuous in our example)
6	Skew inputs to be defined
7	Buttons to restore the default input values
8	Buttons to validate the inputs (Pressing the “enter key” twice applies inputs too).
9	Skew outputs (read only)
10	Button to export the skew data into *.txt or *.xlsx files.

## 1.6.2.2 Set a skew angle

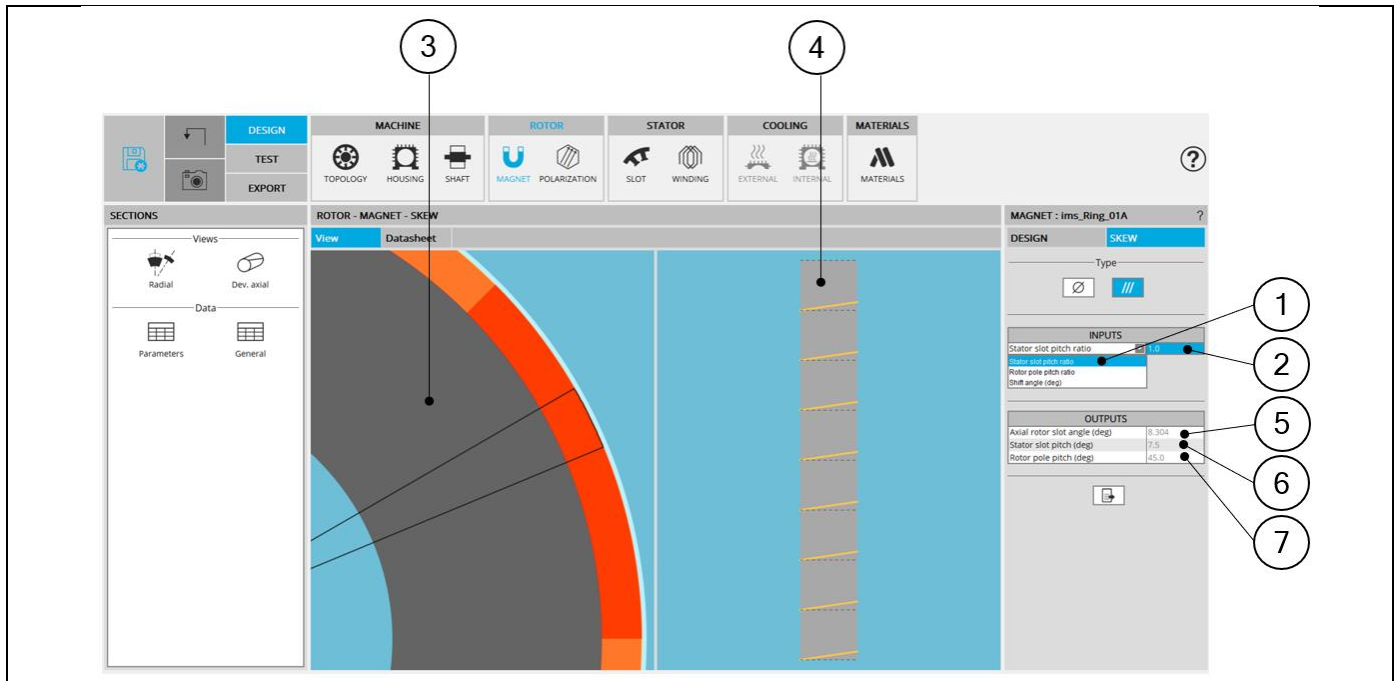

## How to set a skew angle?

1	Choose the definition mode of the skew: Stator slot – Rotor slot – Shift angle
2	Definition of the skew angle depending on the definition mode
3	Visualization of the chosen skew angle on the machine radial view
4	Visualization of the equivalent axial slot angle on the rotor developed view
5	Equivalent axial rotor slot angle (read only)
6	Equivalent stator slot pitch (read only)
7	Equivalent rotor slot pitch (read only)

Note: The user can add a skew angle on the rotor or on the stator. If a skew is already defined in the stator when setting a skew on the rotor, the stator skewing will be automatically reset to “None”.

## 1.7 Polarization

### 1.7.1 Overview

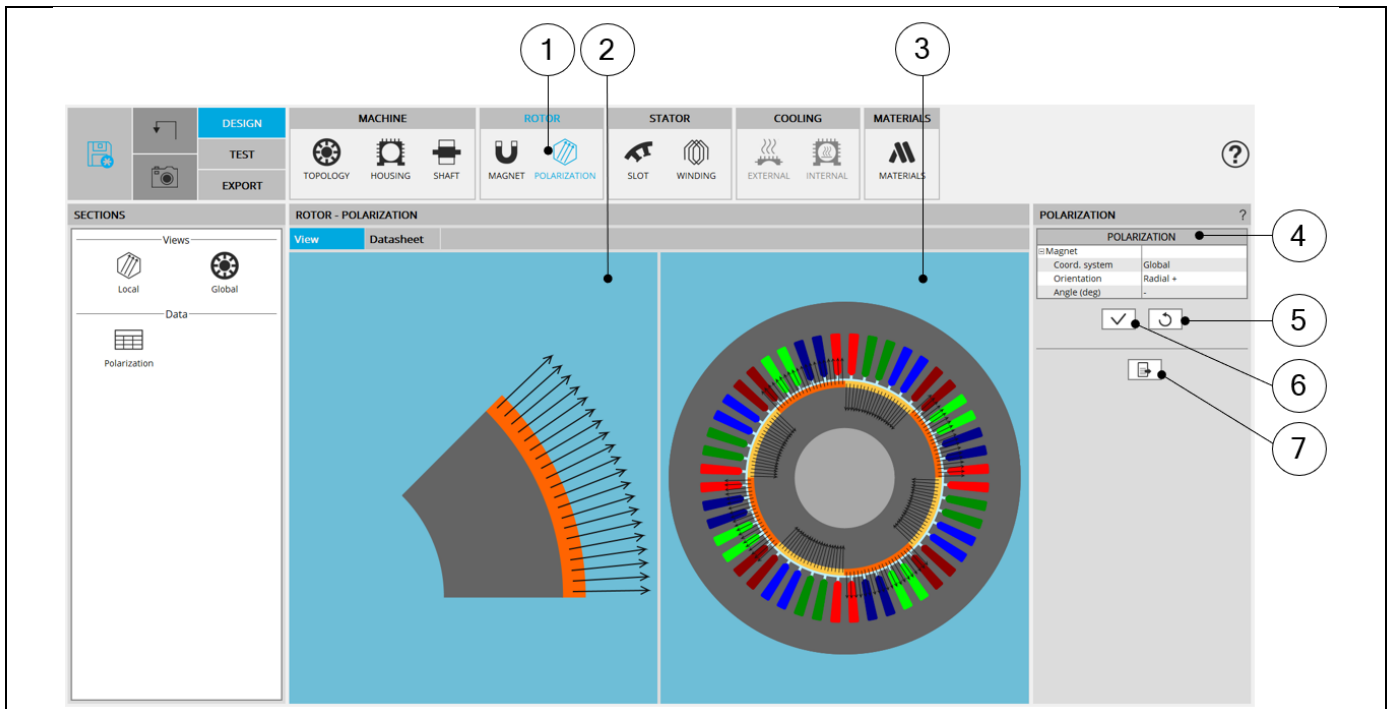

POLARIZATION design area

1	Selection of the ROTOR subset: POLARIZATION panel (Click on the icon POLARIZATION)
2	Visualization of the polarization on one pole.
3	Visualization of the polarization on the whole machine.
4	Area to choose the polarization strategy. Five types of orientation and two coordinate systems and angle are available. See additional information below.
5	Button to restore default input values. Default polarization is defined in Part Factory application via Excel file. See "Part Factory" application for more information.
6	Button to Apply inputs. Pressing the enter key twice applies inputs too.
7	Icon to export polarization data into *.txt or *.xlsx files.

### 1.7.2 Choice of polarization

#### 1.7.2.1 Polarization coordinate system

Two coordinate systems are available:

A **"Global"** polarization coordinate system: The origin is positioned at the rotor center.

A **"Local"** polarization coordinate system which is specific to each considered magnet topology.

Note: The reference axis (X-axis for Cartesian coordinate system) has a red color.

#### 1.7.2.2 Polarization orientation

Five strategies of polarization are proposed:

- Direction
- Radial +, Radial –
- Orthoradial +, Orthoradial –

1.7.2.3 Polarization orientation illustrations

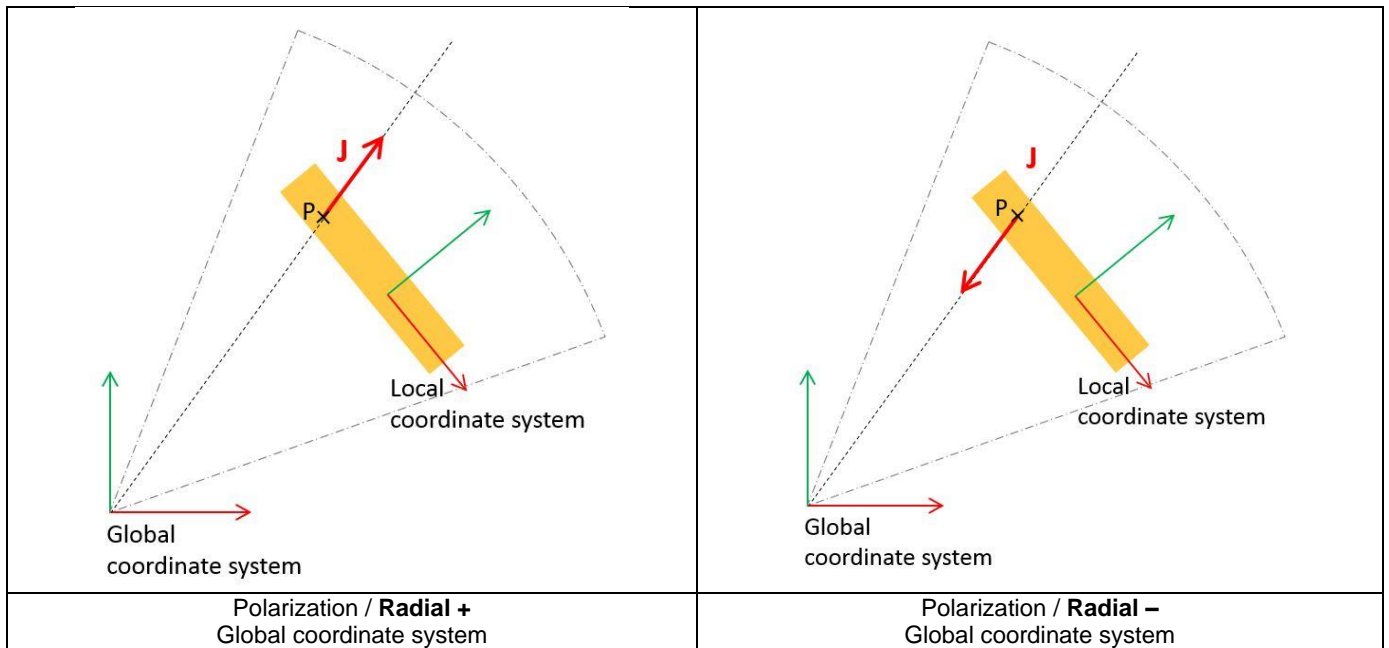
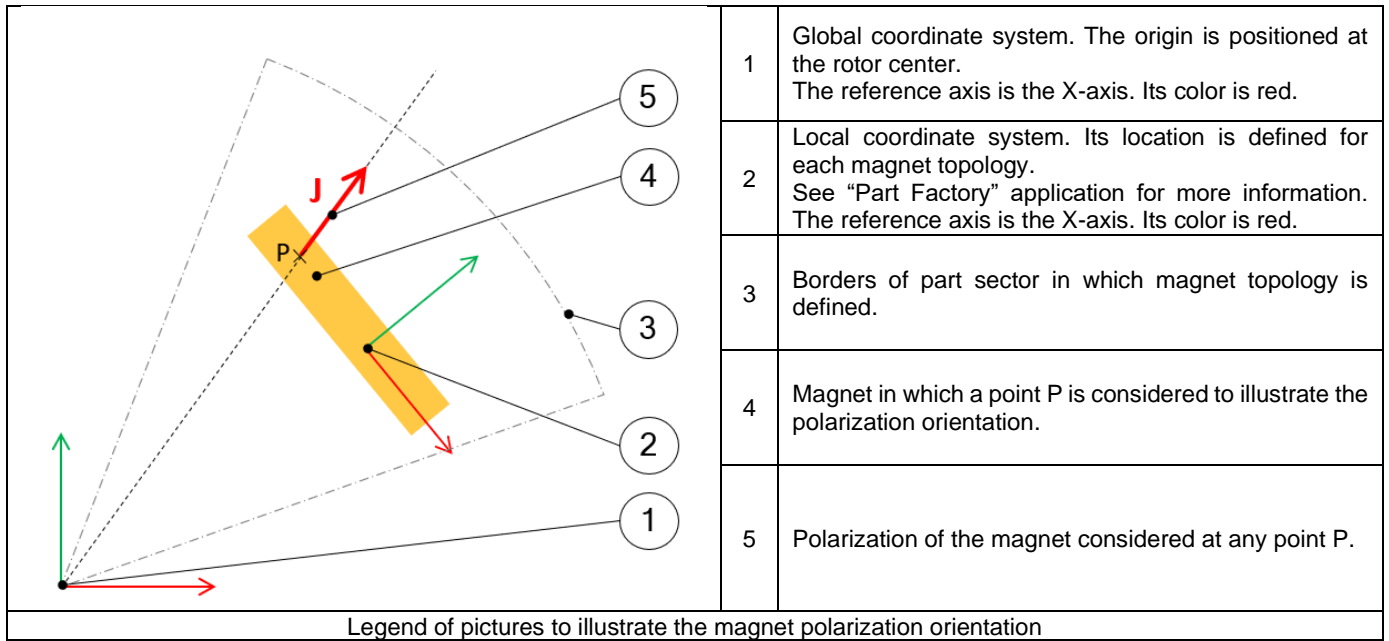

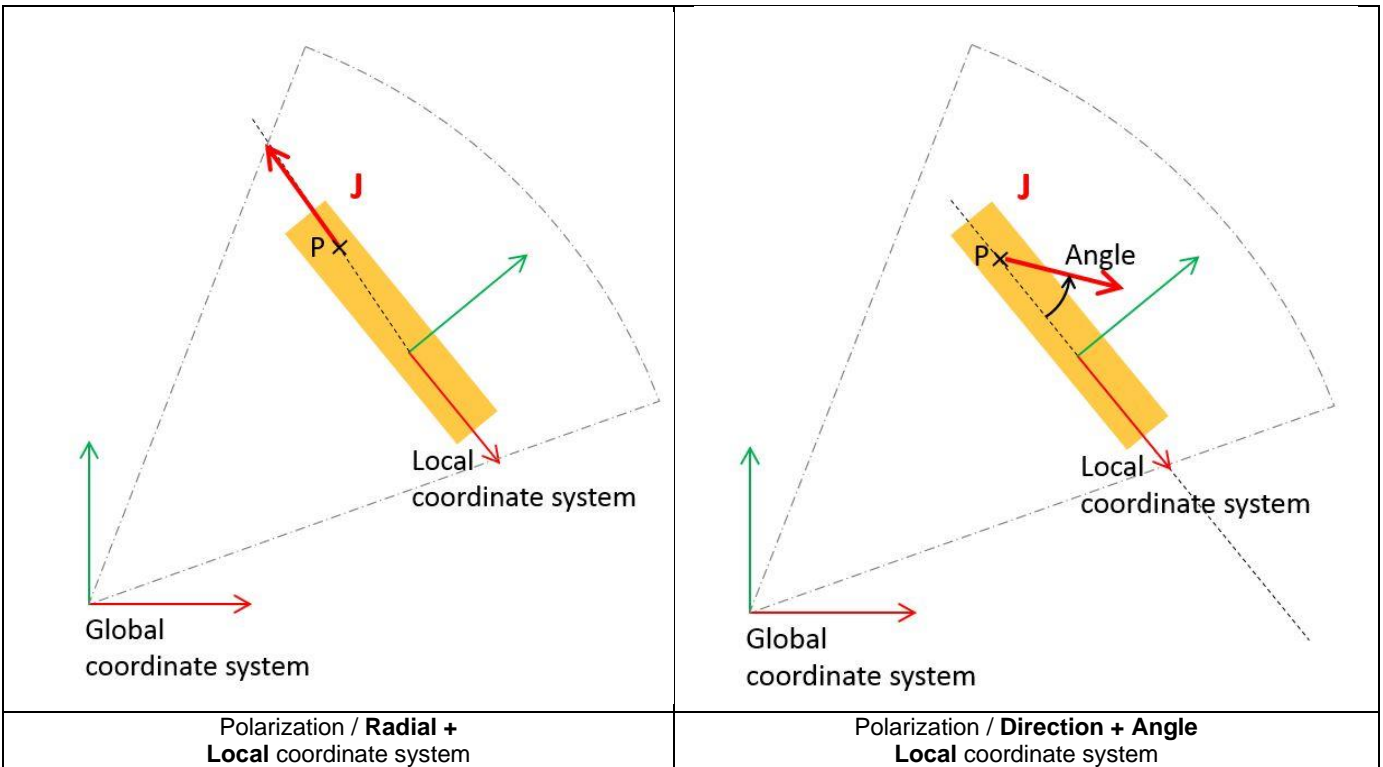
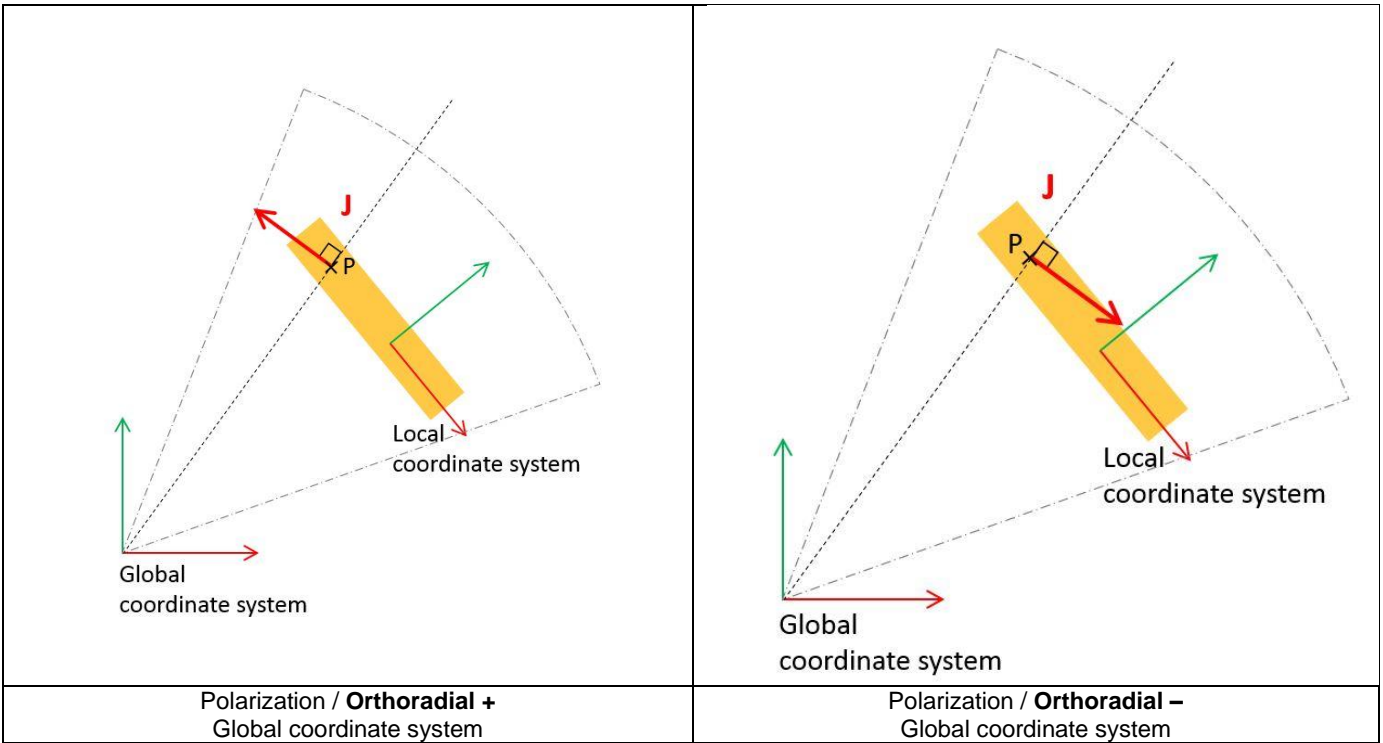

## 1.8 Slot

### 1.8.1 Overview

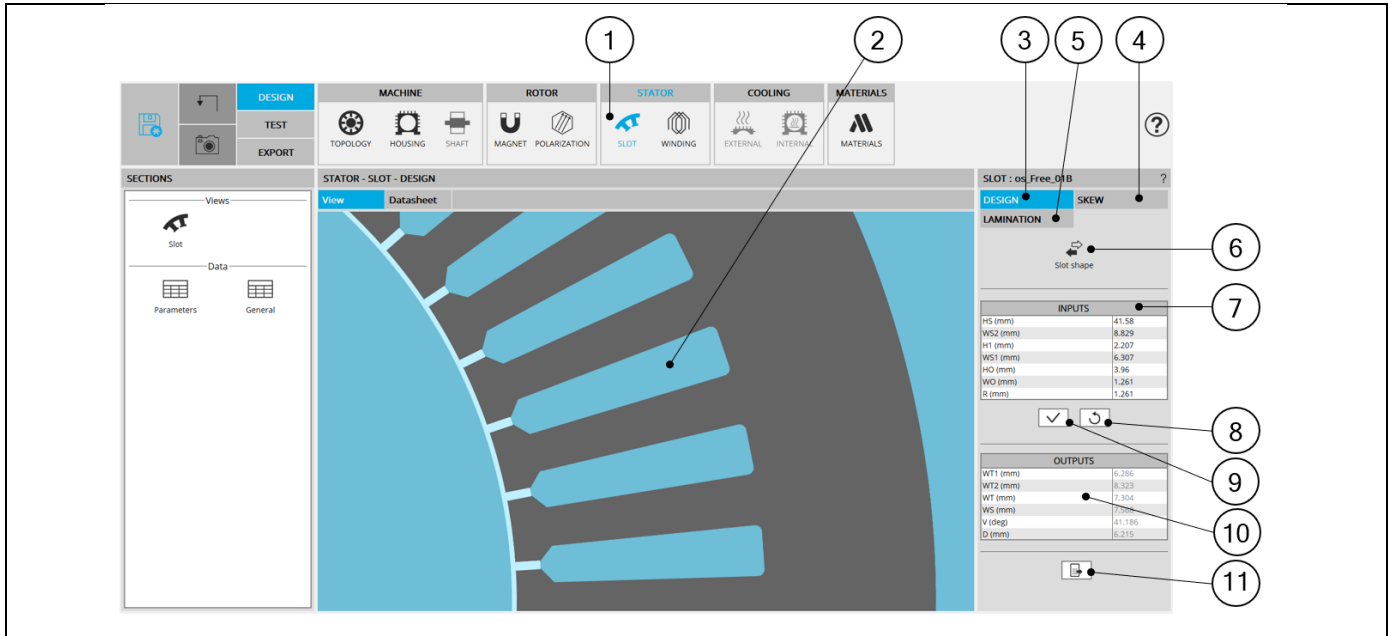

SLOT design area

1	Selection of the STATOR subset: SLOT panel (Click on the icon SLOT)
2	Visualization of the motor radial view to see the slot topology and dimensions.
3	DESIGN tab indicates the tools to define the slot parameters. Note: By default, Design tab is selected.
4	SKEW tab indicates the tools to define the slot skew angle
5	LAMINATION tab indicates the tools to define the shape of the lamination. Note: By default, Circular lamination is selected.
6	"Slot shape" button allows accessing the slot libraries to change the slot topology. See additional information below.
7	User input parameter fields to enter the value.
8	Button to restore default input values.
9	Button to Apply inputs. Pressing the enter key twice applies inputs too.
10	Output parameters (read only data) to complete the description of the topology.
11	Icon to export slot data into *.txt or *.xlsx files.

## 1.8.2 Slot - Design

### 1.8.2.1 Slot shape - Choose a slot topology

Clicking on the "Slot shape" button opens a dialog box, allowing access to the slot libraries. It allows visualizing, comparing, choosing, and importing another slot topology to modify in the current stator design.

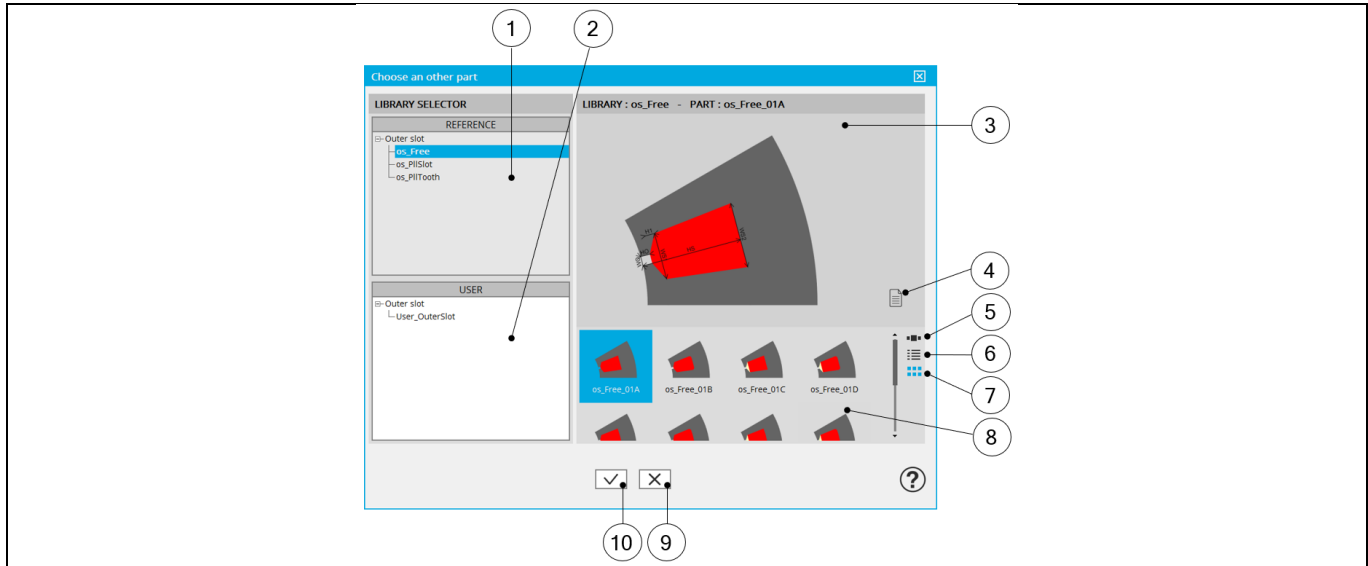

How to choose another slot topology?

1	Visualization of reference libraries i.e. the libraries of slot topologies provided with FluxMotor®. Select them to view their content and choose the slot among them. See “Part Library” application for more information.
2	Visualization of user libraries. The default user library is “UserOuterSlot” See “Part Library” application for more information.
3	Area where the selected slot is displayed (static picture) – Topology + dimension labels.
4	Button to visualize the list of documents attached to the part. See additional information below.
5	Button to display thumbnails as a slide show.
6	Button to display thumbnails as a list.
7	Button to display thumbnails as a matrix view of pictures.
8	Area to visualize all the topologies of slots from the selected library (ref. 1).
9	Button to close the dialog box and come back to Motor Factory – DESIGN – Slot area.
10	Button to choose and import the selected slot to modify the current stator design.

### 1.8.2.2 Attached documents – Additional information

	<table border="1"> <tr> <td>1</td> <td>Attached document list after having clicked on button to display it (4).</td> </tr> <tr> <td>2</td> <td>“+” or “-” non-active buttons from “Motor Factory”. See “Part Library” application for more information.</td> </tr> <tr> <td>3</td> <td>List of attached documents (if present). A double click on the selected document opens it. Documents can be added only from Part Library application. See “Part Library” application for more information.</td> </tr> <tr> <td>4</td> <td>Button to show or hide the attached document list.</td> </tr> </table>	1	Attached document list after having clicked on button to display it (4).	2	“+” or “-” non-active buttons from “Motor Factory”. See “Part Library” application for more information.	3	List of attached documents (if present). A double click on the selected document opens it. Documents can be added only from Part Library application. See “Part Library” application for more information.	4	Button to show or hide the attached document list.
1	Attached document list after having clicked on button to display it (4).								
2	“+” or “-” non-active buttons from “Motor Factory”. See “Part Library” application for more information.								
3	List of attached documents (if present). A double click on the selected document opens it. Documents can be added only from Part Library application. See “Part Library” application for more information.								
4	Button to show or hide the attached document list.								
Visualization of attached documents									



### 1.8.2.3 Inputs / Outputs

Specific inputs and outputs are considered for each slot topology.

The relevance of input parameters values can be evaluated by using “Part Factory” application. See “Part Factory” application for more information.

Outputs are read only data. They complete the description of the topology.

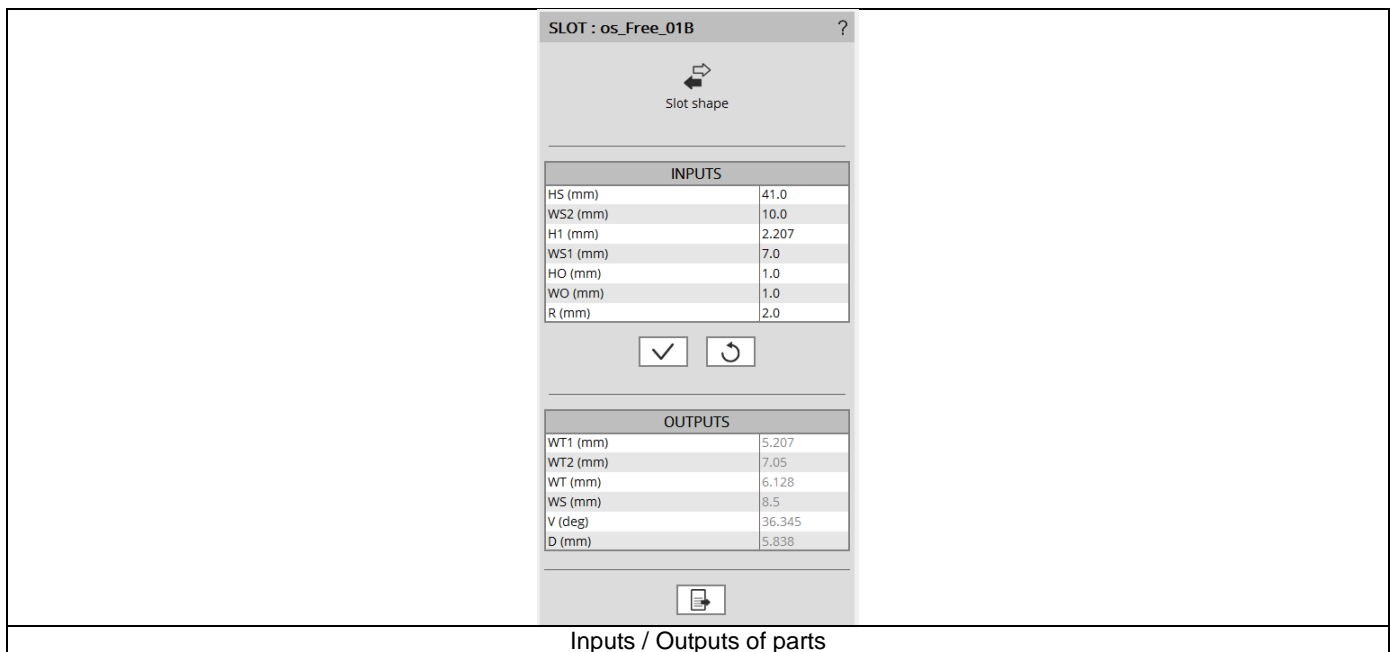

The screenshot shows a configuration window for a slot topology. At the top, it is titled 'SLOT : os\_Free\_01B'. Below the title is a 'Slot shape' section with a double-headed arrow icon. The main area is divided into two tables: 'INPUTS' and 'OUTPUTS'. Below the tables are checkmark and refresh icons, and a print icon at the bottom.

INPUTS	
HS (mm)	41.0
WS2 (mm)	10.0
H1 (mm)	2.207
WS1 (mm)	7.0
HO (mm)	1.0
WO (mm)	1.0
R (mm)	2.0

OUTPUTS	
WT1 (mm)	5.207
WT2 (mm)	7.05
WT (mm)	6.128
WS (mm)	8.5
V (deg)	36.345
D (mm)	5.838

Inputs / Outputs of parts

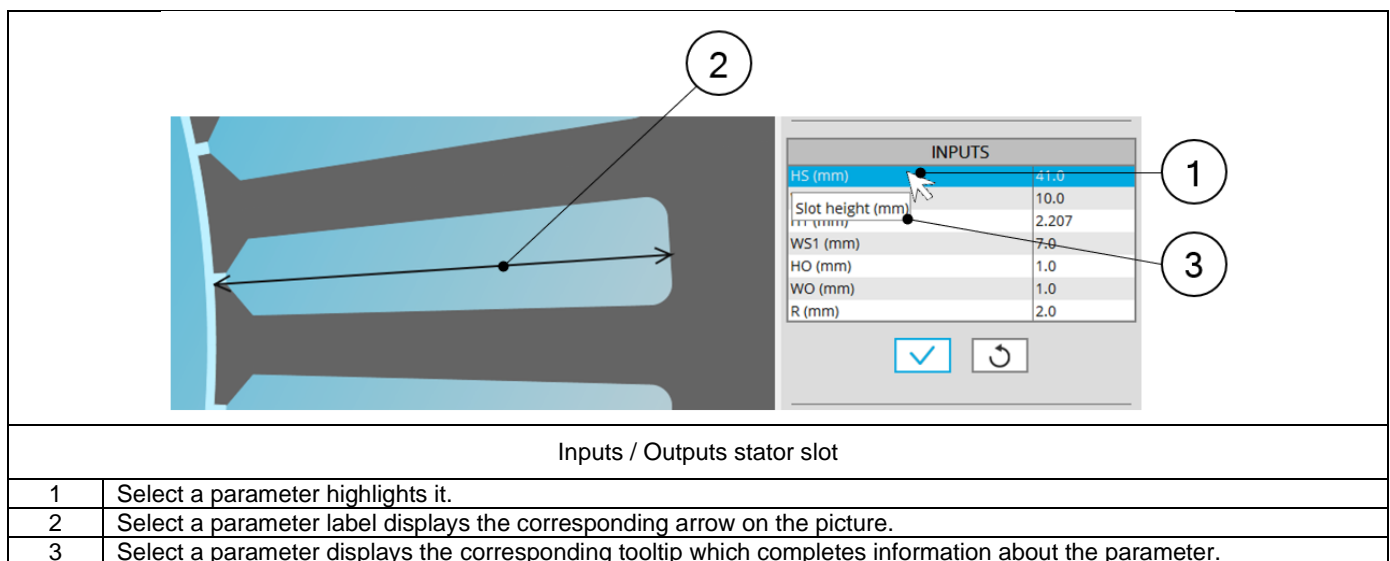

The diagram shows a cross-section of a stator slot. A configuration window is overlaid on the right side, showing the 'INPUTS' table. Three callouts are present: 1 points to the 'HS (mm)' row, 2 points to the 'Slot height (mm)' row, and 3 points to the 'HS (mm)' row. Arrows from callout 2 point to the slot height in the diagram.

INPUTS	
HS (mm)	41.0
Slot height (mm)	10.0
WS1 (mm)	7.0
HO (mm)	1.0
WO (mm)	1.0
R (mm)	2.0

Inputs / Outputs stator slot

1	Select a parameter highlights it.
2	Select a parameter label displays the corresponding arrow on the picture.
3	Select a parameter displays the corresponding tooltip which completes information about the parameter.

## 1.8.3 Slot – Skew

## 1.8.3.1 Overview

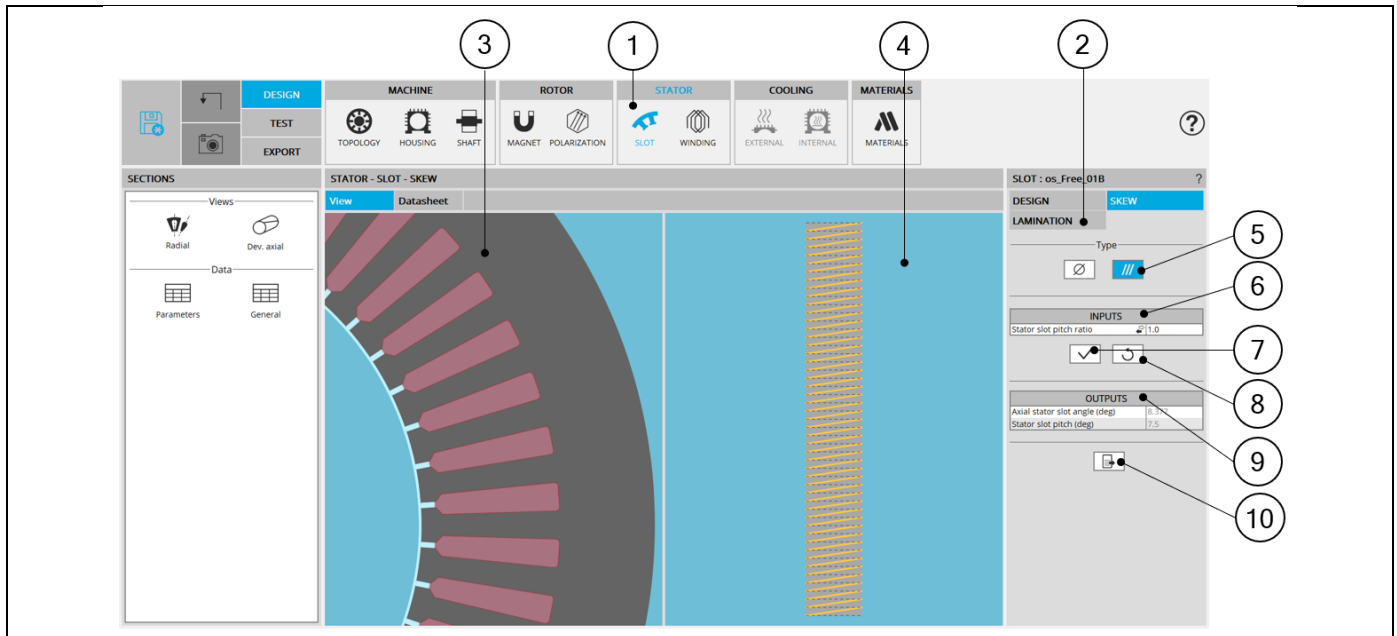

## SLOT – SKEW design area

1	Selection of the STATOR subset: SLOT panel (Click on the icon SLOT)
2	Skew tab indicates the tool to define the slot skew angle
3	Visualization of the machine radial view to visualize the slot skew
4	Visualization of the stator developed view to visualize the slot skew
5	Choices to define a skew: None – Continuous (Continuous in our example)
6	Skew inputs to be defined
7	Buttons to validate the inputs (Pressing the “enter key” twice applies inputs too).
8	Buttons to restore the default input values.
9	Skew outputs (read only)
10	Button to export the skew data into a text file

## 1.8.3.2 Set a skew angle

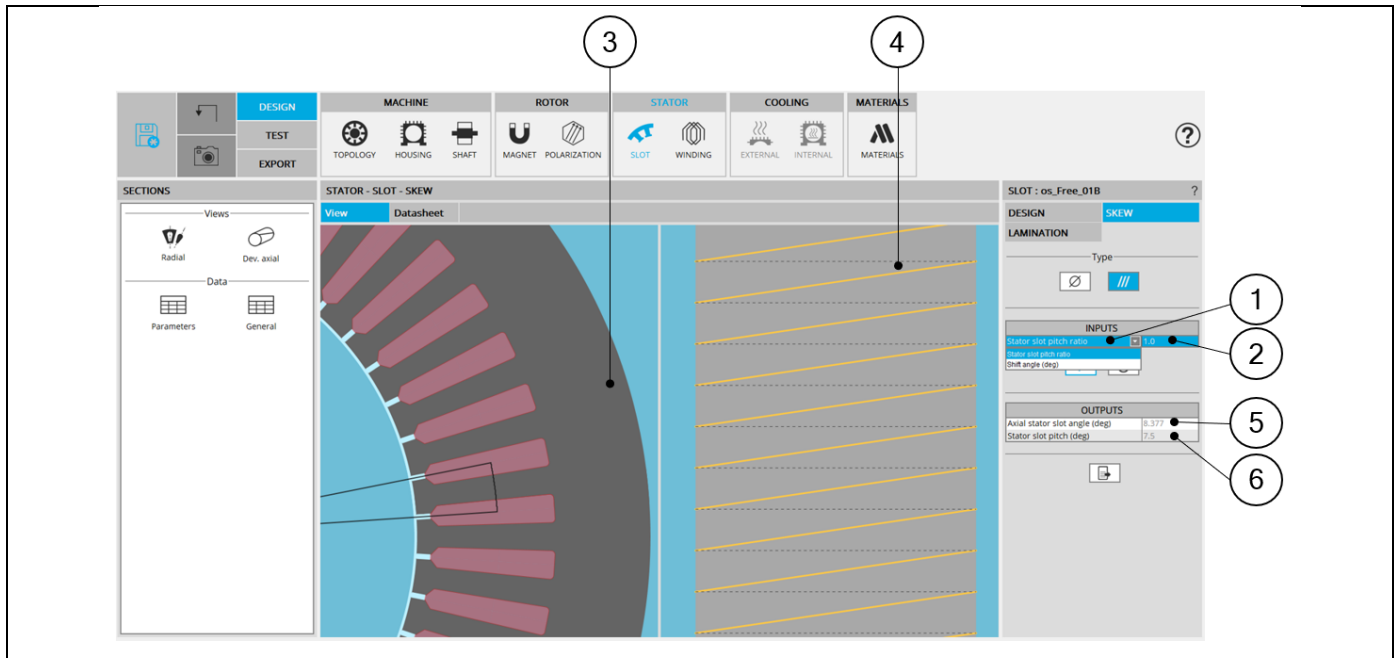

## How to set a skew angle?

1	Choose the definition mode of the skew: Stator slot – Shift angle
2	Definition of the skew angle depending on the definition mode
3	Visualization of the chosen skew angle on the machine radial view
4	Visualization of the equivalent axial slot angle on the rotor developed view
5	Equivalent axial stator slot angle (read only)
6	Equivalent stator slot pitch (read only)

Note: The user can add a skew angle on the rotor or on the stator. If a skew is already defined in the rotor when setting a skew on the stator, the rotor skewing will be automatically reset to “None”.

### 1.8.4 Slot – Lamination

#### 1.8.4.1 Overview

The tools available in the lamination tab allow in defining the outer shape of the lamination.

Three choices are available to define the lamination topology: None, Circular or Square.

By default, the outer shape of the lamination is defined by considering the outer diameter of the stator (defined in structural data).

When the choice of lamination is “None”, original structural data of the stator are considered.

In that case outer shape of lamination is circular without extensions. Outer dimensions of lamination are indicated in general data (structural data part). See illustration below.

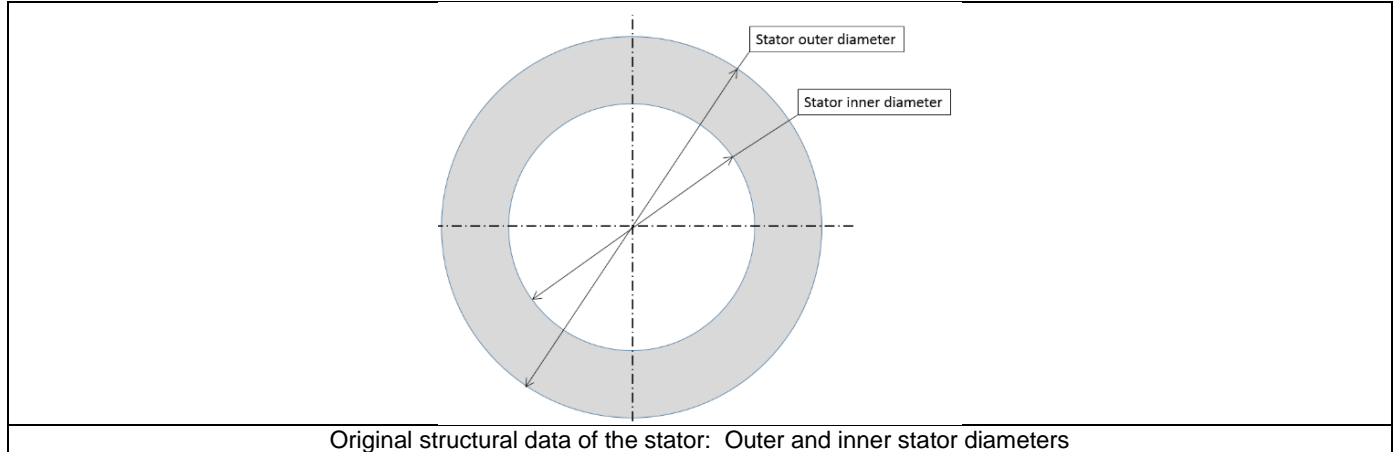

#### 1.8.4.2 Circular shape lamination

	1	Choice of a circular shape lamination
	2	Additional lamination extension. This corresponds to a diameter extension from the original stator outer diameter defined in the general data (structural data of the machine). See illustration below. For new design, this input won't be available anymore.
	3	Button to restore default input values.
	4	Button to Apply inputs. Pressing the enter key twice applies inputs too.
	5	Icon to export lamination data into *.txt or *.xlsx files.

	1	Extension = Diameter extension from the original stator outer diameter. <b>Note: For new design, this input won't be available anymore.</b>
	2	Original stator outer diameter defined in the general data (structural data of the machine).

1.8.4.3 Square shape lamination

1) Main inputs

	<ol style="list-style-type: none"> <li>1 Choice of a square shape lamination.</li> <li>2 Corner type available (Right, Chamfer, Fillet).</li> <li>3 Button to select "fillet" type corner.</li> <li>4 Button to select "chamfer" type corner.</li> <li>5 Button to select "right" type corner.</li> <li>6 User input parameters to define the angular shifting of the stator. <b>Note: For new design, extension won't be available any more.</b></li> <li>7 Button to restore default input values.</li> <li>8 Button to apply inputs. Pressing the enter key twice applies inputs too.</li> <li>9 Icon to export lamination data into *.txt or *.xlsx files.</li> </ol>
<p>Dialog box to define the square shape lamination</p>	

2) Description of the different kinds of square shape lamination available

<p>Square shape lamination with right corner</p>	<p>Square shape lamination with chamfer corner Setting of the length corresponding to a 45° chamfer</p>
<p>Square shape lamination with fillet corner Setting of the lamination fillet radius</p>	<p>Square shape lamination with right corner See the link with stator outer diameter</p>

## 3) Definition of the slot angular shift

With a square shape lamination, it is possible to set a slot angular shift. It is advised to keep an angular shift lower than one slot pitch. This parameter allows adjusting outer dimension ( $\Delta$ ) between outer border of the lamination and the bottom part of slots. For more details see the illustrations below.

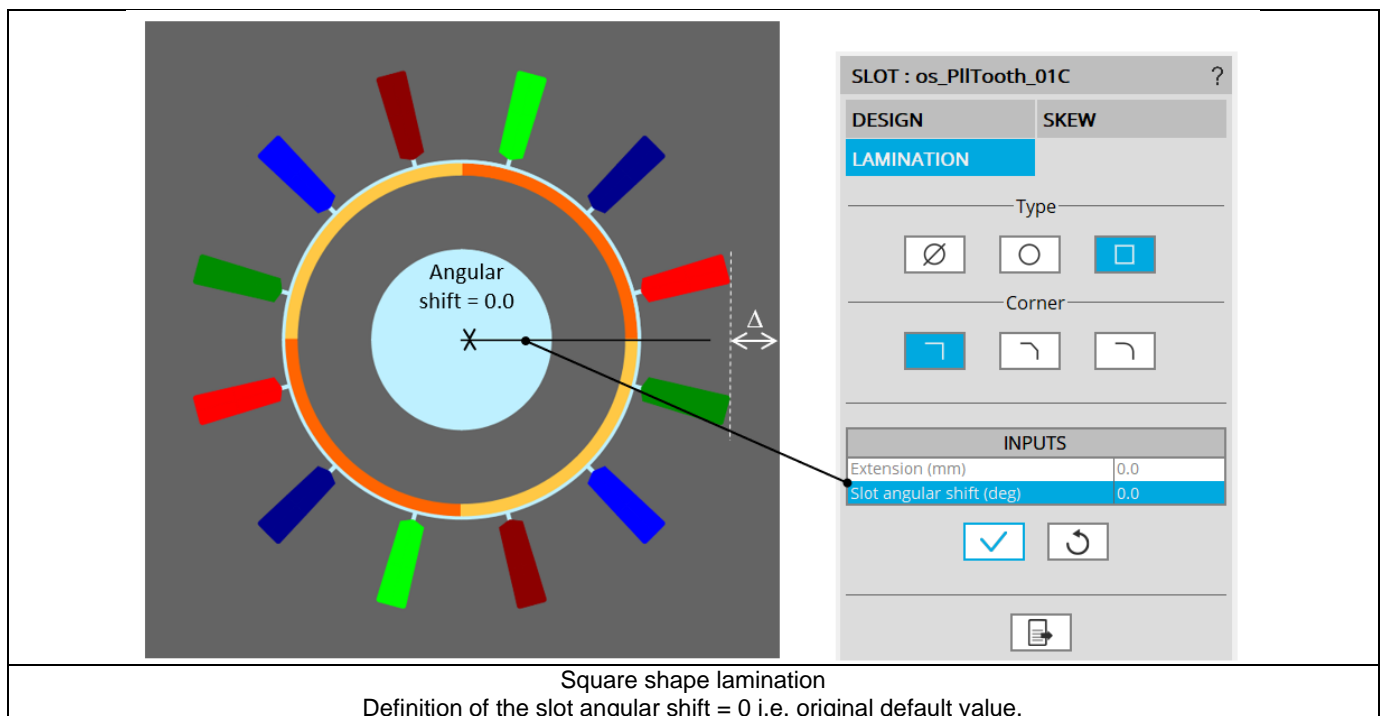
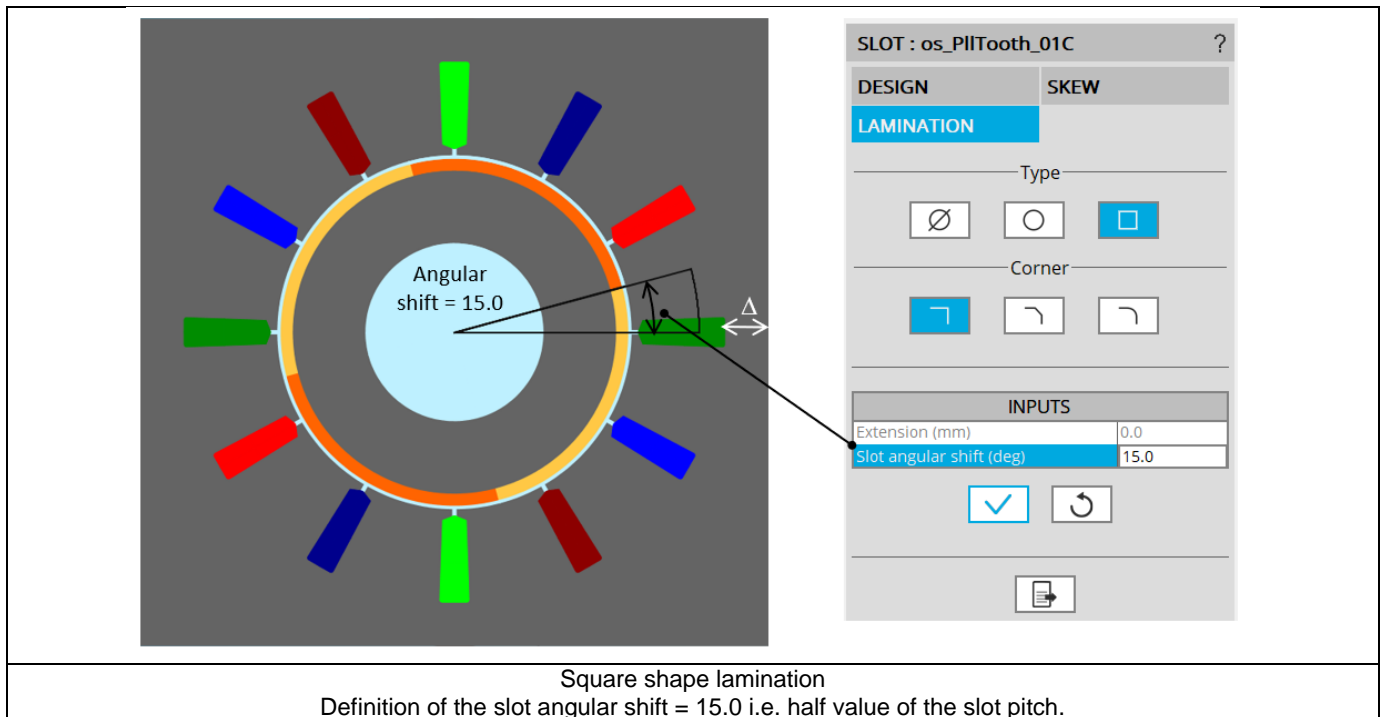

## 1.9 Winding

Please refer to the user help guide:

“.MotorFactory\_2022.3\_3Phase\_Winding” which is dedicated to the 3-Phase winding design General user information.

For both types of winding, whether classical or hairpin, the home page characteristics are the same. The following picture illustrates the main areas of the home page which is displayed for the classical winding.

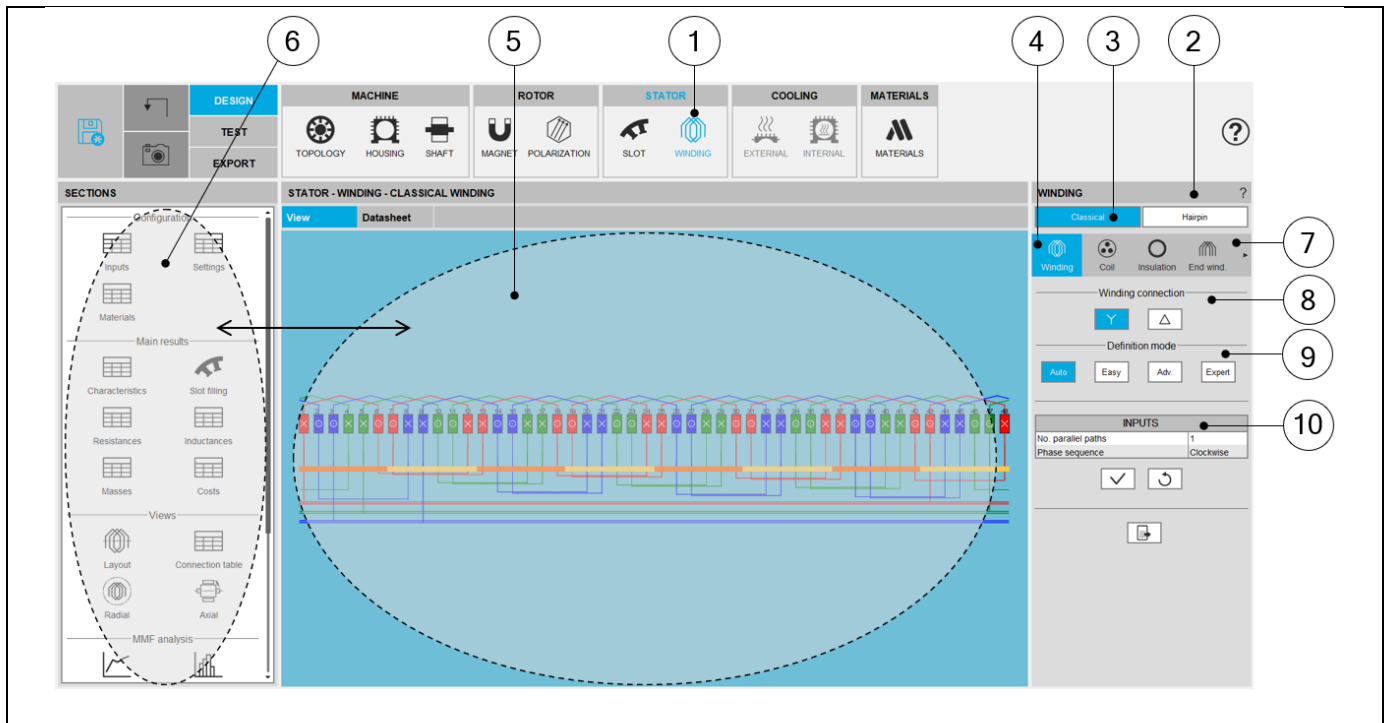

WINDING design area – Classical winding - Overview

1	Selection of the STATOR subset: WINDING panel (Click on the icon WINDING)
2	All the required user inputs to define the winding are available in the “WINDING” panel (right part).
3	Selection of the classical winding design (Highlighted in blue)
4	Winding settings allow describing the winding architecture
5	Once a winding is defined, the corresponding results are automatically displayed in the form of a winding report. Visualization of the winding characteristics (inputs, settings, materials, etc) are possible. Scrollbars allow browsing the whole document rapidly and giving an overview of all the results. Using scrollbars, complete data can be accessed and visualized.
6	Shortcuts for displaying the corresponding section of the winding report.
7	A section scrolling bar allows choosing the section in which user inputs are defined. Scrolling selection bar where Winding architecture, Coil, Insulation, End-winding, X-Factor and Potting sections can be selected
8	Choice of the winding connection: Y (Wye) or $\Delta$ (Delta)
9	Four modes of winding allow to <b>define and build the winding architecture</b> .
Auto	<b>Automatic</b> mode, used as default.
Easy	<b>Easy</b> mode, to choose solution among those FluxMotor® proposes.
Adv.	<b>Advanced</b> mode, to allow the user to define any specific input parameters.
Expert	<b>Expert</b> mode, to set the connection table.
10	User input parameter fields to enter the values according to the considered mode.



Scrolling selection bar – Winding environment

1	Scrolling selection bar where Winding, Coil, End-winding, X-Factor and Potting sections can be selected
2	Section data can be reached thanks to shortcuts
3	Arrow allows scrolling the bar to reach other sections (on the right or the left) when needed
4	The bar slides on the right to allow reaching Potting section

Note: This mode of section selection is applied for hairpin winding environment as well.



## 1.10 External cooling

### 1.10.1 Overview

This step allows defining the thermal modeling of the cooling of the external part of the frame.

This area is unlocked only once a housing is defined, in the MACHINE subset, HOUSING design area.

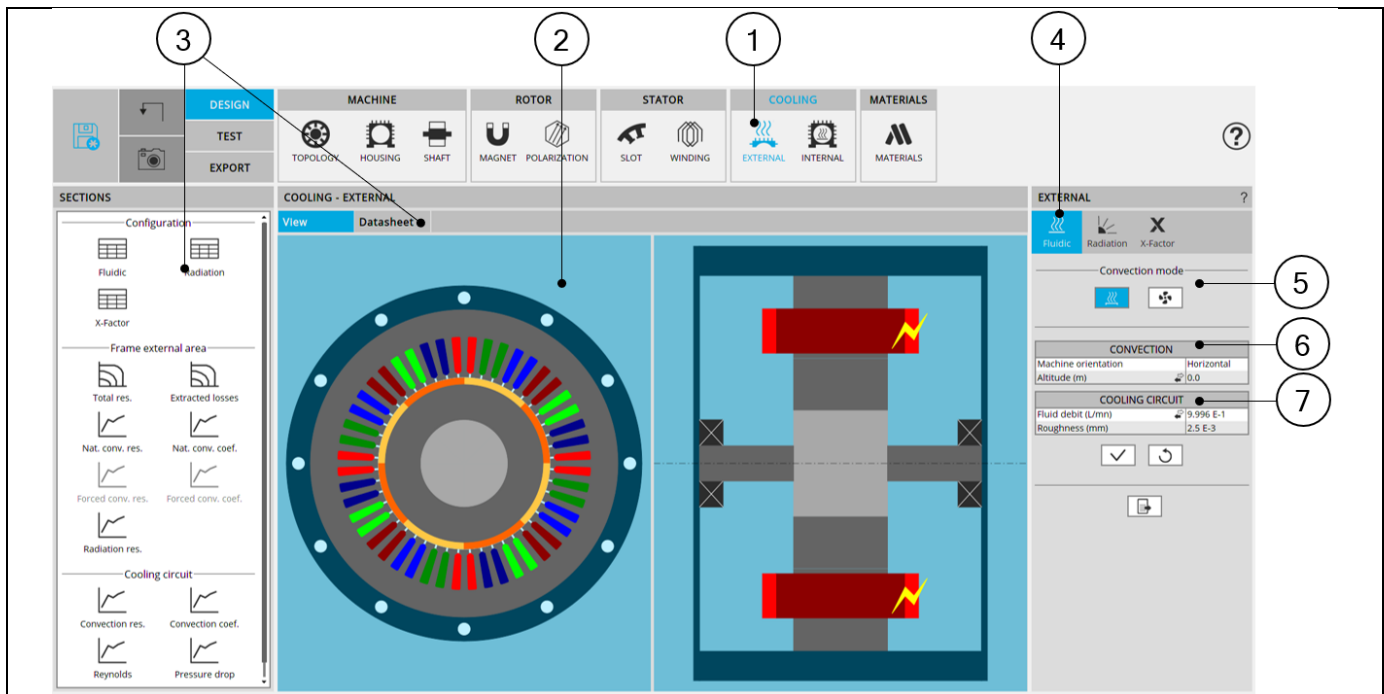

EXTERNAL COOLING design area - Overview

1	Selection of the COOLING subset: EXTERNAL panel (Click on the icon EXTERNAL)
2	Once the external cooling parameters are defined, corresponding results are automatically displayed in the form of a report.
3	Visualization of the external cooling characteristics (inputs, and corresponding results) is possible in a datasheet. Scrollbars allow browsing the whole document rapidly and having an overview of all the results. Using scrollbars, complete data can be accessed and visualized. Shortcuts for displaying the corresponding chapter of the external cooling report.
4	External cooling settings allow describing the external cooling parameters
5	Choice of the external convection mode: natural or forced
6	Inputs defining the convection (forced or natural, corresponding to the choice above)
7	Inputs defining the fluid flow in the cooling circuit. This table is available only when a cooling circuit has been defined by the user in the MACHINE subset, HOUSING panel, CIRCUIT setting.

## 1.10.2 Advice for use

### 1.10.2.1 Hypothesis on fluidic computations

Due to the hypothesis made in fluidic computations, some non-continuity can be observed in the fluid convection coefficient evolution, especially in the airgap and on the frame. These non-linearities and possible non-continuities are related to the change from laminar to turbulent fluid flow.

### 1.10.2.2 Validity domain of the fluidic computations

The fluidic computation embedded in FluxMotor® uses analytical laws. For some specific fluid properties, extreme temperatures, and very low forced cooling velocity, the computations made can be out of this validity domain.

In this case, some errors will occur, asking to check the fluid properties, and the velocity involved in the forced convection.

For advanced usages that the hypothesis on fluid flow does not cover, it is advised to set a “user convection coefficient” manually for these specific regions.

### 1.10.2.3 Frame convection and cooling circuit convection

Frame convection and cooling circuit convection are key parameters to understand the thermal behavior of the machine.

FluxMotor provides some internal models to estimate the convection occurring in the cooling circuit and on the frame.

It must be kept in mind that the FluxMotor® functions are provided to be used in predesign steps: these convection coefficients are given to illustrate general tendencies but will differ to the accurate convection occurring on the machine. For advanced uses, it is advised to consider these coefficients carefully, and to do additional CFD computation to improve the results quality.

The FluxMotor® model has been validated for machines surrounded by air. The user can select other external fluids, but this go beyond the validation done on the software.

### 1.10.2.4 Temperature considered for fluidic computations

Some fluidic computations are based on two different temperatures: the temperature of the fluid, and the temperature of the wall from where the convection occurs.

This explains that the convection results shown in the design environment can be slightly different from the results obtained in the test environment.

In the design environment, the fluid and the wall are at the same evaluation temperature, but in the test the wall and the fluid temperatures are evaluated during the solving and are different in most of the cases.

## 1.10.3 Fluidic – Inputs

### 1.10.3.1 Overview

The tools available in the fluidic tab allow defining the parameters that drive the convection phenomenon cooling the frame:

- On the external surfaces of the frame and of the end caps
- In the cooling circuit, when a cooling circuit is defined by the user in the MACHINE subset, HOUSING panel, CIRCUIT setting.

Two choices are available to define the convection occurring on the external surface of the frame and of the end caps. Natural or Forced.

By default, Convection mode is set to “Natural”.

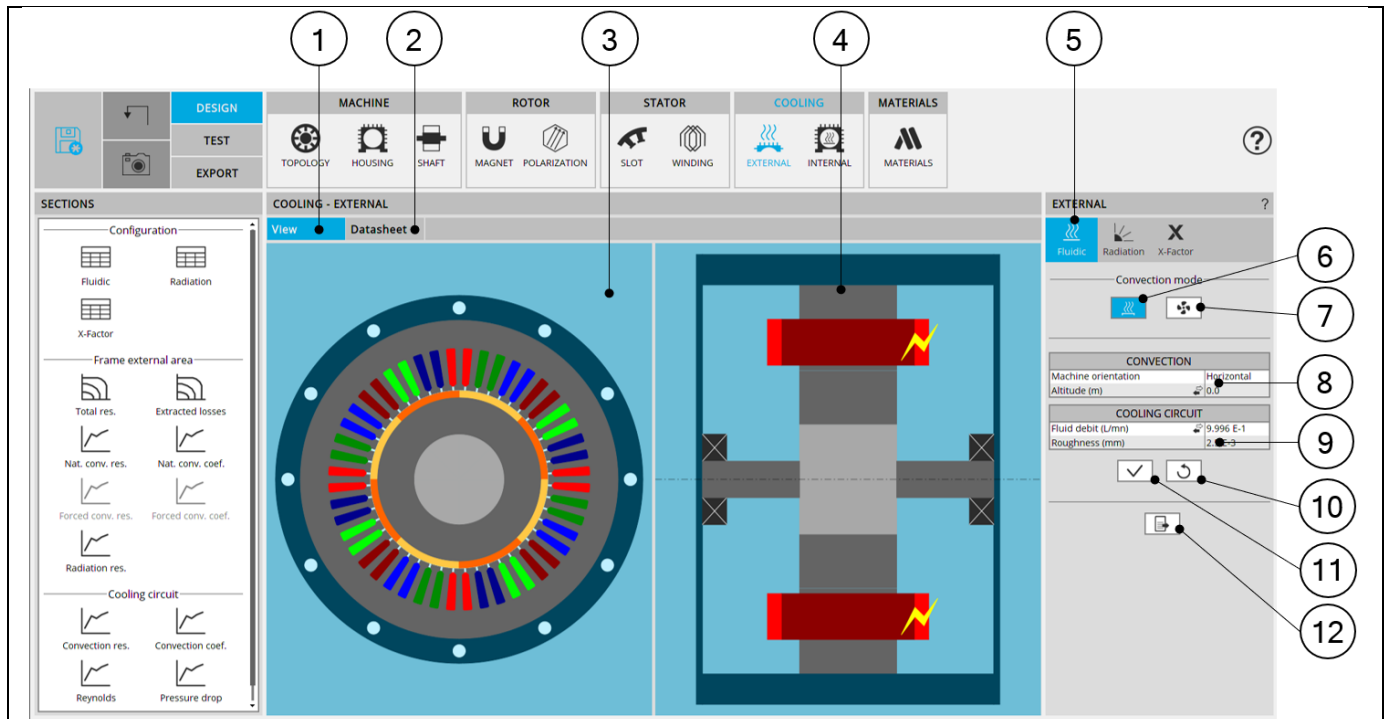

External cooling - Fluidic design area

1	Display the axial and radial view of the machine.
2	Display the external cooling datasheet, showing the main thermal parameters of the frame cooling.
3	Radial view of the motor, where specific exchange areas can be highlighted depending on the selected input.
4	Axial view of the motor, where specific exchange areas can be highlighted depending on the selected input.
5	The section fluidic is selected.
6	Selected button to set that the external areas of the frame and the end caps are cooled by natural convection (no forced fluid flow).
7	Selected button to set that the external areas of the frame and the end caps are cooled by forced convection (forced fluid flow around the machine).
8	Input related to the fluidic corresponding to the selected convection mode.
9	Input related to the cooling circuit, when a cooling circuit exists.
10	Button to restore default input values.
11	Button to apply inputs. Pressing the enter key twice applies inputs too.
12	Icon to export external cooling data into *.txt or *.xlsx files.

### 1.10.3.2 Natural convection

This convection mode corresponds to no forced fluid velocity around the machine. When selecting this mode, the only convection modeled is the fluid convection movement due to the difference of fluid temperatures (giving a difference of fluid density) close to the frame compared with the fluid far from the frame.

For instance, for a totally enclosed machine, cooled by natural convection in air, the frame will be hotter than the air close to it. This will warm the air surrounding the frame, feeding a natural « convective pump » due to the difference of air densities close and far from the frame (the hotter air having a lower density).

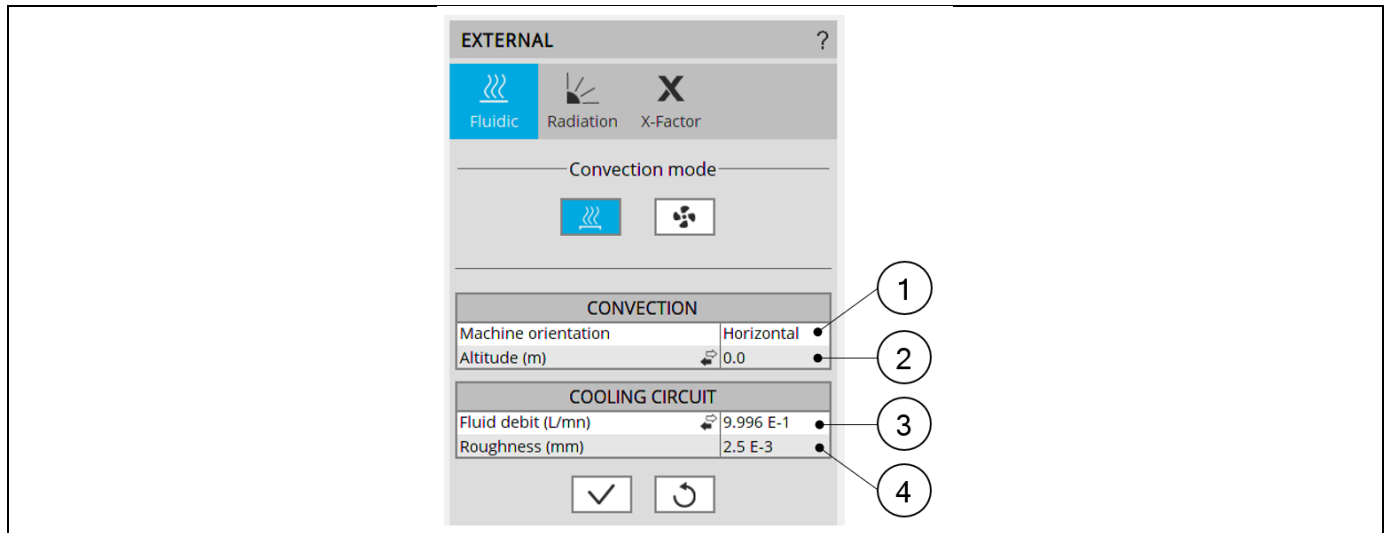

#### Natural convection - Inputs

1	Machine orientation. The resulting orientation can be seen in the axial view of the machine. The machine orientation has an impact only on the natural convection occurring on the external surface of the frame and the end caps
2	Altitude or Pressure (depending on the input mode selected by the user).  The pressure has an impact on the gas properties, changing the convection (natural and forced) occurring inside and outside the frame. This pressure can be set directly as a pressure, or as an altitude of use of the machine depending on the user choice. When selecting the altitude, an internal model computes the equivalent atmospheric pressure to consider for the convection computations. Notes: <ul style="list-style-type: none"> <li>This input (altitude or pressure) has an impact on gas involved in both external and internal convection phenomenon.</li> <li>The convection model for liquid is based on the hypothesis of non-compressible fluid. When the external or internal fluid is a liquid (meaning it is not a gas), this input is ignored for the corresponding convection phenomenon.</li> </ul>
3	Fluid debit or Fluid velocity (depending on the input mode selected by the user). This input exists only when a cooling circuit has been defined by the user in the MACHINE subset, HOUSING panel, CIRCUIT setting. It corresponds to the fluid flow debit or velocity existing in the cooling circuit. This input will be considered for every thermal computation, including the tests (and not only for the model evaluation in the external cooling design environment).
4	The roughness of the cooling circuit pipe is only considered to compute the regular pressure losses in the cooling circuit and does not affect the computation of the temperatures.

### 1.10.3.3 Forced convection

This convection mode allows adding forced convection in addition to the natural convection that always exists. When selecting this mode, the effect of the forced fluid flow around the machine is detailed separately of the natural convection in the results.

The resulting convection occurring on the machine is a mix of natural convection and forced convection.

EXTERNAL
?

  
 Fluidic

  
 Radiation

  
 X-Factor

Convection mode  





CONVECTION

Machine orientation	Horizontal	●
Flow origin	C.S.	●
Fan tip speed ratio	2.0	●
Altitude (m)	0.0	●

COOLING CIRCUIT

Fluid debit (L/mn)	9.996 E-1	●
Roughness (mm)	2.5 E-3	●

✓

↻

1

2

3

4

5

6

Natural convection - Inputs	
1	Machine orientation. The resulting orientation can be seen in the axial view of the machine. The machine orientation has an impact only on the natural convection occurring on the external surface of the frame and of the end caps
2	Flow origin. This describes the origin of the fluid flow cooling the external surfaces of the frame and the end caps. The flow can come from the Connection Side or from the Opposite Connection Side. Arrows are displayed in the axial view of the machine to illustrate the user choice.
3	Fan tip speed ratio or Constant fluid speed or Forced convection coefficient. (depending on the input mode selected by the user). This input describes the forced convection phenomenon existing on the outer surfaces of the frame and of the end caps. Please refer to additional information below.
4	Altitude or Pressure (depending on the input mode selected by the user). The pressure has an impact on the gas properties, changing the convection (natural and forced) occurring in and out of the frame. This pressure can be set directly as a pressure, or as an altitude of use of the machine depending on the user choice. When selecting the altitude, an internal model computes the equivalent atmospheric pressure to consider for the convection computations. Notes: <ul style="list-style-type: none"> <li>This input (altitude or pressure) has an impact on gas involved in both external and internal convection phenomenon.</li> <li>The convection model for liquid is based on the hypothesis of non-compressible fluid. When the external or internal fluid is a liquid (meaning it is not a gas), this input is ignored for the corresponding convection phenomenon.</li> </ul>
5	Fluid debit or Fluid velocity (depending on the input mode selected by the user). This input exists only when a cooling circuit has been defined by the user in the MACHINE subset, HOUSING panel, CIRCUIT setting. It corresponds to the fluid flow debit or velocity existing in the cooling circuit. This input will be considered for every thermal computation, including the tests (and not only for the model evaluation in the external cooling design environment).
6	Roughness: The roughness of the cooling circuit pipe is only considered to compute the regular pressure losses in the cooling circuit and does not affect the computation of the temperatures.

**EXTERNAL** ?

Fluidic Radiation X-Factor

Convection mode

Machine orientation: Horizontal

Flow origin: C.S.

Fan tip speed ratio: 2.0

Altitude (m): 0.0

Fluid debit (L/mn): 9.996 E-1

Roughness (mm): 2.5 E-3

#### Natural convection - Inputs

1	<p>Fan tip speed ratio or Constant fluid speed or Forced convection coefficient. (depending on the input mode selected by the user). This input describes the forced convection phenomenon existing on the outer surfaces of the frame and of the end caps.</p> <p>The fan tip speed ratio describes the ratio between the fluid velocity and the tip speed of the rotor. This describes the behavior of a shaft mounted fan which rotation depends on the speed of the rotor.</p> <p>Then, when using this input, the external fluid velocity along the frame will be proportional to the rotation speed of the rotor</p>
2	<p>The user set the ratio between the fan blade tip speed (the tip of the blades being considered at the frame external radius, without considering the possible fins and the velocity of the fluid projected by the fan).</p> <p>The default value is 2. This corresponds to average fans, where the tip speed of the fan blade is two time higher than the average speed of the fluid projected by the fan.</p> <p>Lower this ratio will be, more efficient will be the cooling (because with a lower ratio, the coolant velocity will be higher at a given rotation speed of the rotor)</p> <p>Constant fluid speed input can be used to model a fixed coolant velocity, whatever the rotor speed is. It allows modeling an external cooling system blowing air on the machine without dependency of the machine.</p> <p>Forced convection coefficient input allows experts to directly force in the model a forced convection coefficient. This coefficient describes only the “forced” component of the convection. This forced convection set by the user will be added to the natural convection by an internal computation. The impact of the natural and forced components of the cooling can be seen in the outputs.</p>

## 1.10.4 Radiation – Inputs

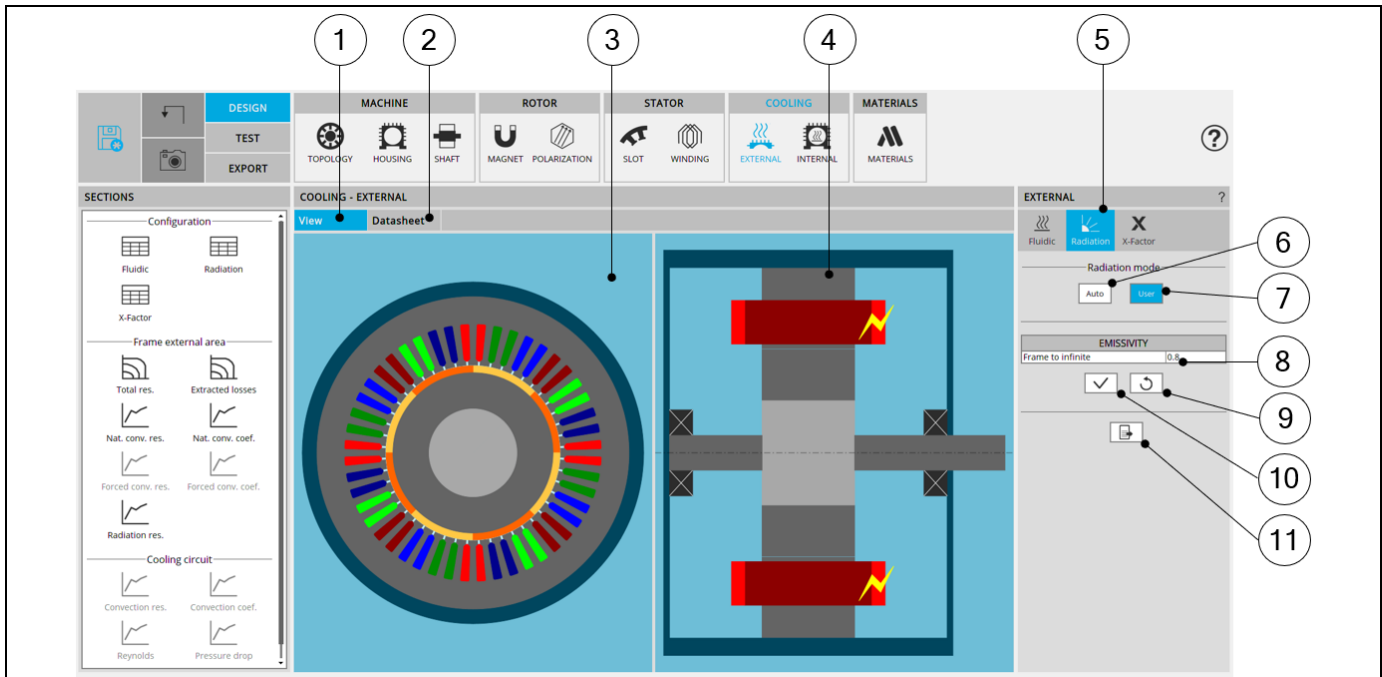

External cooling - Radiation design area

1	Display the axial and radial view of the machine.
2	Display the external cooling datasheet, showing the main thermal parameters of the frame cooling.
3	Radial view of the motor, where specific exchange areas can be highlighted depending on the selected input.
4	Axial view of the motor, where specific exchange areas can be highlighted depending on the selected input.
5	The section radiation is selected.
6	Button to set the external emissivity of the frame by automatic process.
7	Selected button, to set the external emissivity of the frame manually
8	Input related to the radiation corresponding to the selected radiation mode. In user mode, only the Frame to infinite emissivity must be define. The default value is 0.8.
9	Button to restore default input values.
10	Button to apply inputs. Pressing the enter key twice applies inputs too.
11	Icon to export external cooling data into *.txt or *.xlsx files.

## 1.10.5 X-Factors – Inputs

### 1.10.5.1 Overview

The X-Factor panel allows the user to defined calibration factors to tune the thermal modeling on specific resistances. The adjustment factors set in this panel are considered in the results shown in “external cooling” environment, and in the test environment.

The X-Factor panel also contains a set of parameters driving the external cooling (coolant temperatures and rotor speed) allowing the user to evaluate the thermal model embedded.

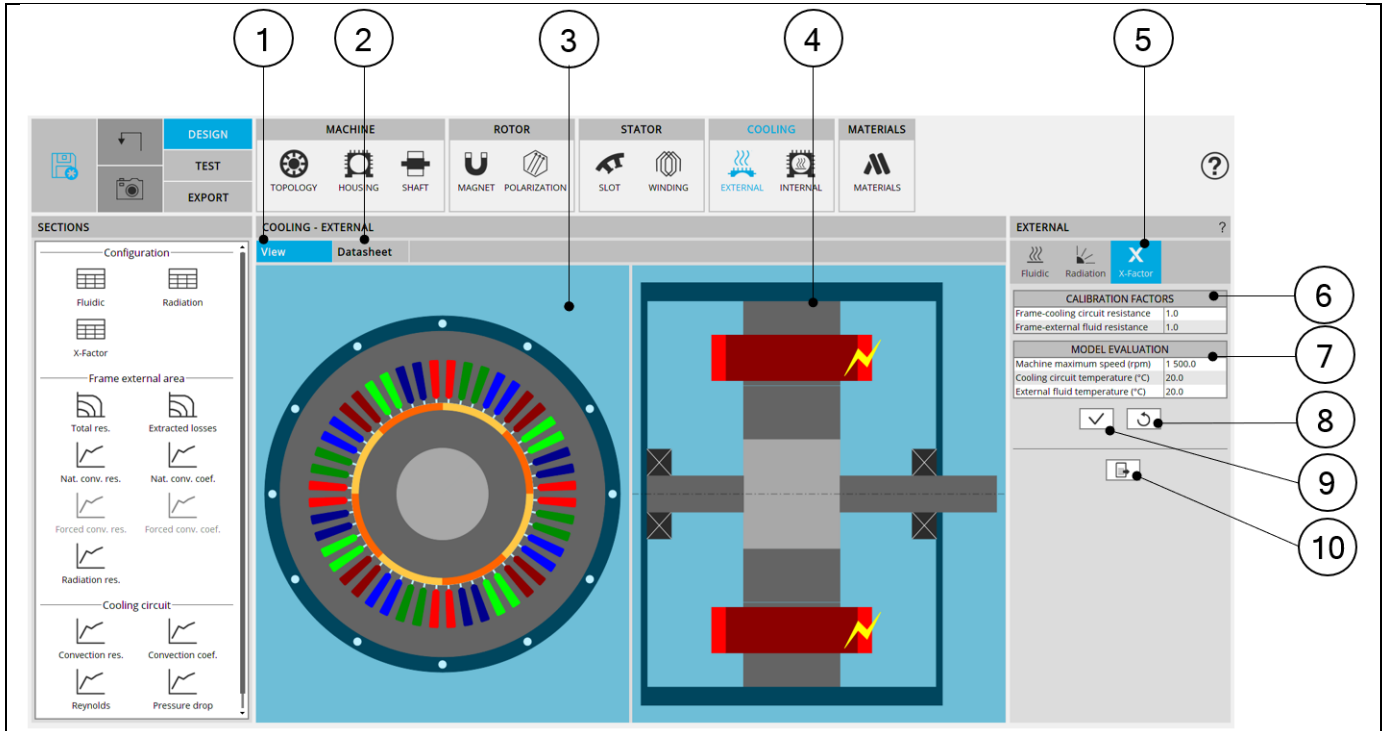

External cooling – X-factor area

1	Display the axial and radial view of the machine
2	Display the external cooling datasheet, showing the main thermal parameters of the frame cooling.
3	Radial view of the motor, where specific exchange areas can be highlighted depending on the selected input.
4	Axial view of the motor, where specific exchange areas can be highlighted depending on the selected input.
5	The section X-Factor is selected.
6	Table of the calibration factors allowing the user to tune the thermal modeling.
7	Input table used for evaluating the external cooling, driving the results displayed in the external cooling datasheet.
8	Button to restore default input values.
9	Button to apply inputs. Pressing the enter key twice applies inputs too.
10	Icon to export external cooling data into *.txt or *.xlsx files.



## 1.10.5.2 Calibration factors

External cooling – Calibration factors input table	
1	<p>Frame-cooling circuit resistance.</p> <p>This calibration factor is applied on the thermal resistance linking the frame and its cooling circuit. This X-factor exists only when a cooling circuit is defined by the user in the MACHINE subset, HOUSING panel, CIRCUIT setting.</p>
2	<p>Frame-external fluid resistance.</p> <p>This calibration factor is applied on every resistance linking the frame and the external fluid:</p> <ul style="list-style-type: none"> <li>• Conduction resistances through the frame and end cap thicknesses</li> <li>• Natural and forced convection resistances</li> <li>• Radiation resistances from the external surfaces of the frame and of the end caps, to the infinite</li> </ul>

## 1.10.5.3 Model evaluation

External cooling – Model evaluation input table	
1	<p>Machine maximum speed.</p> <p>It is the maximum rotation speed for which the forced convection is evaluated in the external cooling datasheet</p>
2	<p>Cooling circuit temperature.</p> <p>It is the temperature used in external cooling panel to evaluate the convection occurring in the cooling circuit. All the results shown for the cooling circuit in external cooling panel and datasheet use this temperature as the temperature of the coolant all along the circuit.</p> <p>This parameter only exists when a cooling circuit has been defined by the user in the MACHINE subset, HOUSING panel, CIRCUIT setting.</p> <p>Note: This temperature is only used for the model evaluation in the external cooling panel. This temperature does not affect the test computations, where the cooling circuit coolant inlet temperature is defined in the settings of the test.</p>
3	<p>External fluid temperature.</p> <p>It is the temperature used in external cooling panel to evaluate the convection and the radiation occurring on external surfaces of the frame and of the end caps. All the results shown for frame and end caps cooling in external cooling panel used this temperature as the temperature of the external fluid at the infinite. The curves and maps are plotted for a temperature of the frame going from this reference temperature to 150 Kelvin above this reference temperature.</p> <p>Note: This temperature is only used for the model evaluation in the external cooling panel. This temperature does not affect the test computations, where the external fluid temperature is defined in the settings of the test.</p>

## 1.10.6 External cooling outputs

### 1.10.6.1 Frame external area

#### 1) Frame to external fluid total thermal resistance in temperature-speed area

This map shows the global thermal resistance used in FluxMotor® model between the frame and the external fluid in a temperature - speed area.

The frame temperature, shown on the X-axis, impacts the natural convection and radiation occurring of each of the frame surfaces (higher is the frame temperature and higher is the temperature difference between the frame and external fluid at the infinite). The map is plotted for a frame temperature going from the external fluid temperature to 150 Kelvin above this reference temperature.

The machine rotation speed, shown on the Y-axis, can impact the forced convection when the user chooses a tip speed ratio to define the force convection.

The global resistance between the frame and the external fluid shown on this graph corresponds to the thermal resistance network shown below.

Three main paths extract the heat from the machine to the external fluid, corresponding to three main components: the straight part of the frame, and the two end caps.

Note: The dimensions of the frame, the Connection Side end cap and the Opposite Connection Side end cap and their physical properties can be defined separately.

Each of these paths extracting heat of the machine is composed of several thermal resistances in series:

- The conduction through the material composing the part
- The convection and radiation occurring from the external surfaces of the frame.

In this network, the convection resistances are mixes of natural and forced components of the convection phenomenon.

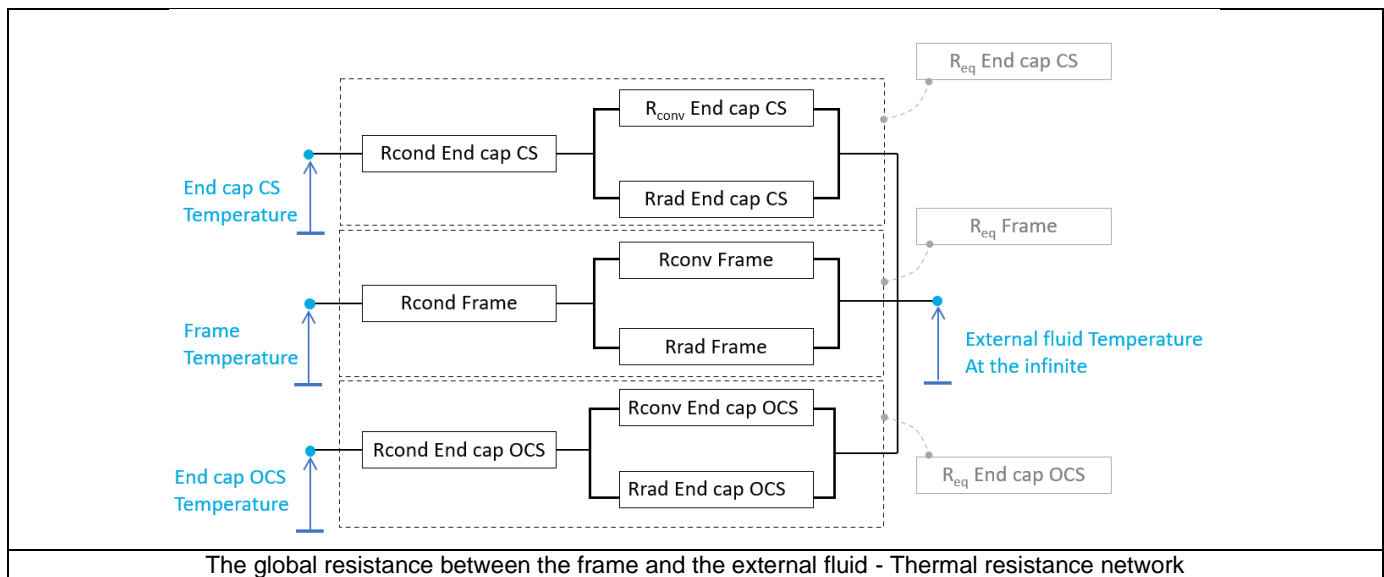

The equivalent thermal resistances defined above are integrated in the global thermal network. The part of this network corresponding to the end parts of the machine is described below.

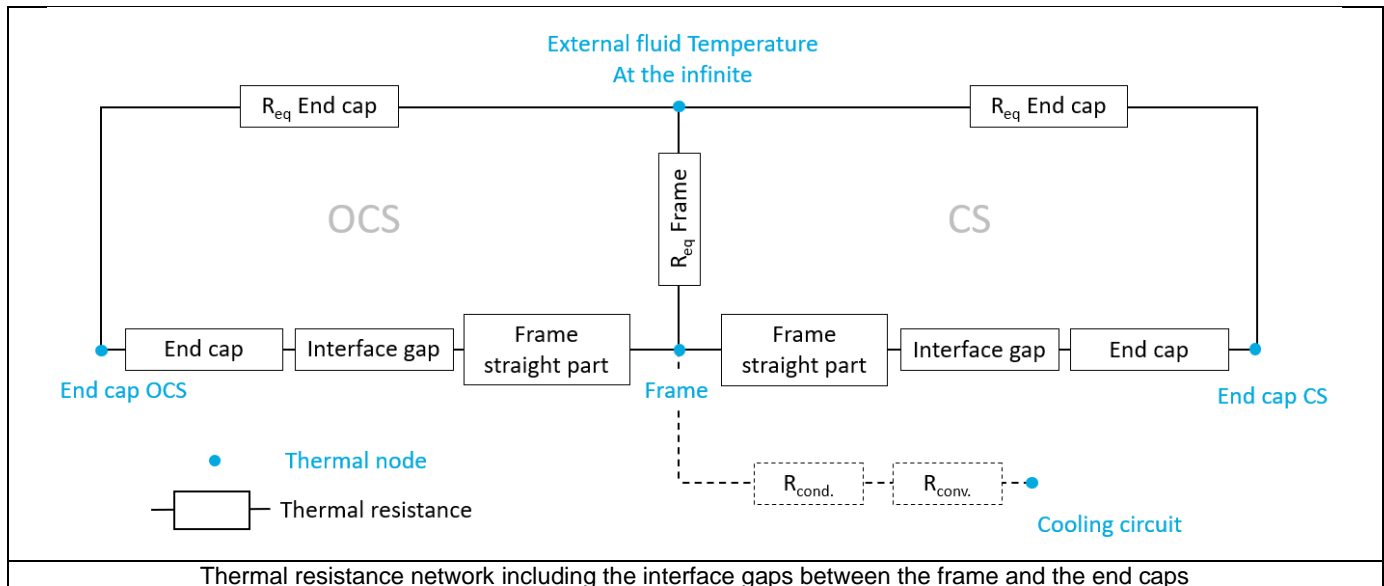

## 2) Losses extracted to external fluid in temperature-speed area

This graph shows the potential of the frame to extract losses in a temperature-speed area.

It shows, for a given frame temperature and a given rotation speed of the machine, how much losses are extracted from the frame to the external fluid, considering that the external fluid is at its reference temperature set by the user in the X-factor settings of External cooling panel.

The map is plotted for a frame temperature going from the external fluid temperature to 150 Kelvin above this reference temperature.

## 3) Frame natural convection versus temperature (Resistance and convection coefficient)

These curves show the natural convection coefficients and resistances existing on each part composing the frame:

- The straight part of the frame
- The Connection Side end cap
- The Opposite Connection Side end cap

These curves are plotted for a frame temperature going from the external fluid temperature set by the user in X-factor settings of External cooling panel, to 150 Kelvin above this reference temperature.

## 4) Frame forced convection versus speed (Resistance and convection coefficient)

These curves show the forced convection coefficients and resistances existing on each part composing the frame:

- The straight part of the frame
- The Connection Side end cap
- The Opposite Connection Side end cap

The curves are plotted for a range of rotor speed going from zero to the maximum speed set by the user in the X-factor settings of External cooling panel.

## 5) Frame radiation versus temperature

These curves show the radiation resistances existing on each part composing the frame:

- The straight part of the frame
- The Connection Side end cap
- The Opposite Connection Side end cap

These curves are plotted for a frame temperature going from the external fluid temperature set by the user in X-factor subset of External cooling panel, to 150 Kelvin above this reference temperature.

### 1.10.6.2 Cooling circuit

#### 1) Cooling circuit convection versus fluid velocity or debit (Resistance and convection coefficient)

These curves show the convection coefficient and resistances existing in the cooling circuit versus the fluid velocity or debit. The convection coefficient and resistance are plotted for speed or debit until the nominal value set by the user in the “Fluidic” settings of External cooling panel.

These curves exist only when a cooling circuit is defined by the user in the MACHINE subset, HOUSING panel, CIRCUIT setting.

#### 2) Cooling circuit Reynolds number versus fluid velocity or debit

This curve shows the Reynolds number existing in the cooling circuit versus the coolant speed or debit. The Reynolds number is plotted for speed or debit until the nominal value set by the user in the “Fluidic” settings of External cooling panel.

This curve exists only when a cooling circuit is defined by the user in the MACHINE subset, HOUSING panel, CIRCUIT setting.

#### 3) Cooling circuit regular pressure drop versus fluid velocity or debit

This curve shows the regular pressure loss existing along the cooling circuit versus the coolant speed or debit. The computation of the regular pressure loss is based on the roughness set by the user, and the Reynolds number in the pipe.

The regular pressure loss is plotted for speed or debit until the nominal value set by the user in the “Fluidic” settings of External cooling panel.

This curve exists only when a cooling circuit is defined by the user in the MACHINE subset, HOUSING panel, CIRCUIT setting

Note: only the regular component of the pressure loss is displayed. The singular pressure losses, due to bend, pumps, section increases, or decreases

## 1.11 Internal cooling

### 1.11.1 Overview

This step allows defining the thermal modeling of the internal cooling, meaning the complex thermal transfers occurring inside the machine.

This panel can be reached only once a housing, a shaft and bearings are defined.

- The housing can be defined in the MACHINE subset, HOUSING panel, FRAME settings.
- The shaft can be defined in the MACHINE subset, SHAFT panel, and SHAFT settings.
- Bearings can be defined in the MACHINE subset, SHAFT panel, and BEARING settings.

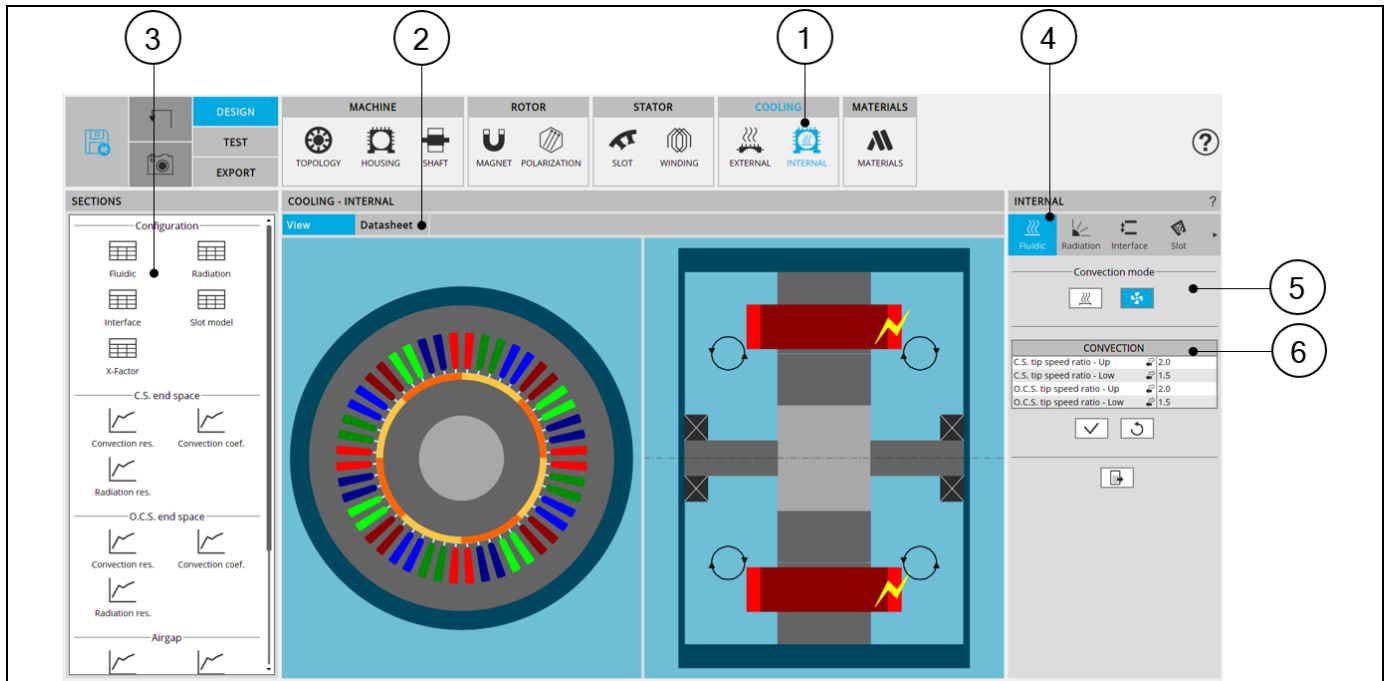

INTERNAL COOLING design area - Overview

1	Selection of the COOLING subset: INTERNAL panel (Click on the icon INTERNAL)
2	Once the internal cooling parameters are defined, corresponding results are automatically displayed in form of datasheet. Visualization of the internal cooling characteristics (inputs, and corresponding results) is possible. Scrollbars allow browsing the whole document rapidly and having an overview of all the results. Using scrollbars, complete data can be accessed and visualized.
3	Shortcuts for displaying the corresponding chapter of the internal cooling datasheet.
4	Internal cooling settings allow describing the internal cooling parameters.
5	Choice of the internal convection mode: natural or forced.
6	Inputs defining the convection (forced or natural, corresponding to the choice above).

## 1.11.2 Advice for use

### 1.11.2.1 Hypothesis on fluidic computations

Due to the hypothesis made in fluidic computations, some non-continuity can be observed in the fluid convection coefficient evolution, especially in the airgap and on the frame. These non-linearities and possible non-continuities are related to the change from laminar to turbulent fluid flow.

### 1.11.2.2 Validity domain of the fluidic computations

The fluidic computation embedded in FluxMotor® uses analytical laws. For some specific fluid properties, extreme temperatures, and very low forced cooling velocity, the computation can be out of this validity domain.

In such cases, some errors will occur, asking to check the fluid properties, and the velocity involved in the forced convection.

For advanced usages, not covered by our hypothesis on fluid flow, it is advised to set a “user convection coefficient” manually for these specific regions.

### 1.11.2.3 Natural convection on end windings

When choosing to model that the end spaces are cooled with natural convection, FluxMotor® model uses a quite low rotor tip speed ratio (a value of 5) to describe the fluid velocity far from the rotating components.

This can lead to overestimates the cooling of the end winding on high-speed machines. This model will be improved for future versions.

When a tip speed ratio of 5 seems to overestimate the end winding cooling, it is advised to switch to forced convection mode.

This mode allows forcing some higher tip speed ratios for areas far from the rotor, this reducing the efficiency of the cooling on the end winding.

### 1.11.2.4 Temperatures considered for fluidic computations

Some fluidic computations are based on two different temperatures: the temperature of the fluid, and the temperature of the wall from where the convection occurs.

This explains that the convection results shown in the design environment can be slightly different from the results obtained in the test environment.

In the design environment, the fluid and the wall are at the evaluation temperature, but in the test the wall and the fluid temperatures are evaluated during the solving and are different in most of the cases.

### 1.11.2.5 Interface thickness usage

The temperatures obtained on a machine highly depend on the interface thicknesses set between each part of the machine. The default interface gap values are set to correspond to classical existing values.

However, keep in mind that the temperatures seen on a real design will deeply depends on the interface qualities, linked to the quality of the mounting process.

Especially, for machines with high density of losses and efficient cooling systems, like water jacket cooled machines, the interface thickness between the frame and the stator yoke is one of the main thermal resistances in the heat extraction. The user must be very careful on the value used for this interface thickness.

The thermal resistances corresponding to the interface thicknesses are computed considering that the interfaces are made of air at 273.15 Kelvin, and at the atmospheric pressure at sea level, 1.013E5 Pa.

### 1.11.2.6 Radiation from the shaft

No radiation is considered from the shaft in FluxMotor® model.

### 1.11.3 Fluidic – Inputs

The tools available in the fluidic tab allow defining the parameters that drive the convection phenomenon in the end spaces, involving the surfaces of the frame (internal surface), the end cap (internal surface), the shaft, the rotor and stator ends, and the end winding or potting.

Two choices are available to define the convection occurring on the external surface of the frame and of the end caps. Natural or Forced.

By default, Convection mode is set to “Natural”.

Note: No inputs exist to define the convection in the airgap, as the convection in the airgap mainly depends on the rotation speed of the rotor and does not depend of the cooling strategy affecting the end spaces.

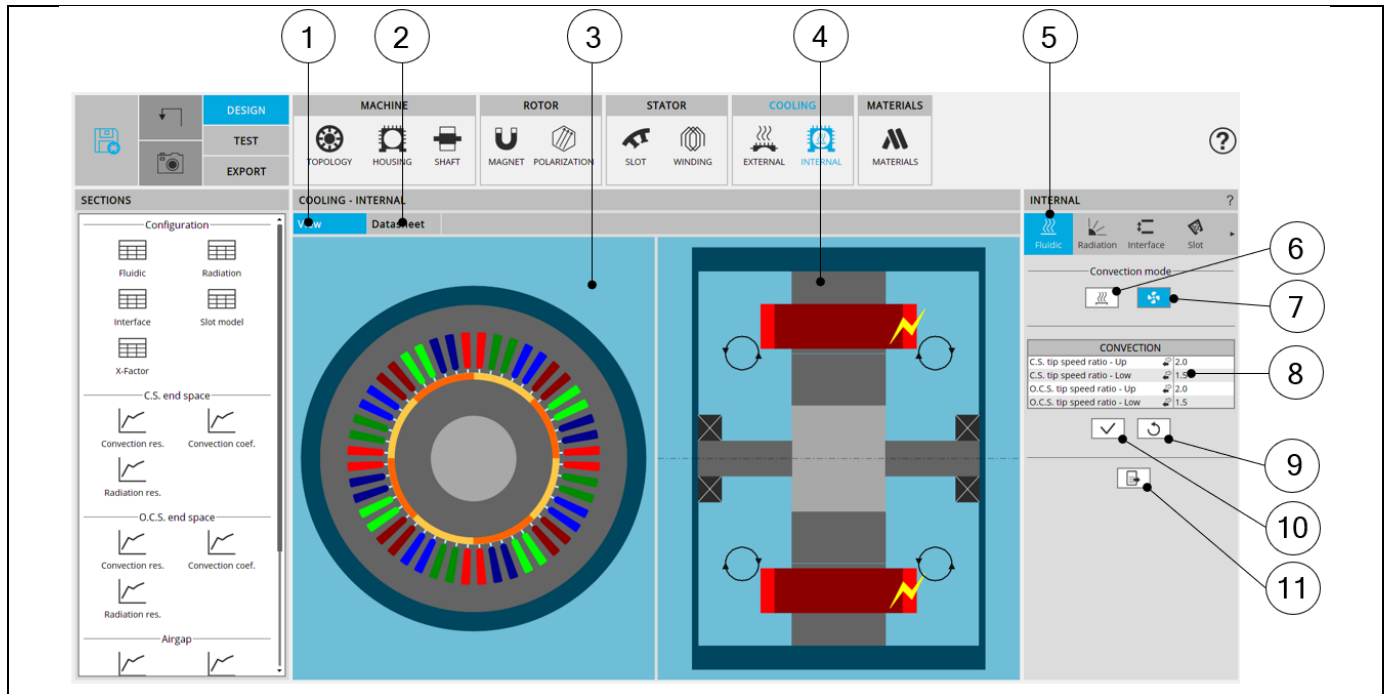

Internal cooling - Fluidic design area

1	Display the axial and radial view of the machine.
2	Display the internal cooling datasheet, showing the thermal parameters defining the internal heat exchanges.
3	Radial view of the motor, where specific exchange areas can be highlighted depending on the selected input.
4	Axial view of the motor, where specific exchange areas can be highlighted depending on the selected input.
5	The section “Fluidic” is selected.
6	Selected button to set that natural convection occurs in the end spaces (no specific fluid flow modeled in addition to the rotation of the machine).
7	Selected button to set that forced convection occurs in the end spaces (a specific fluid flow on each area of the end caps can be specify by the user, that can be linked to the machine rotation speed or not).
8	Input related to the fluidic corresponding to the selected convection mode.
9	Button to restore default input values.
10	Button to apply inputs. Pressing the enter key twice applies inputs too.
11	Icon to export internal cooling data into *.txt or *.xlsx files.

### 1.11.3.1 Natural convection

This convection mode models that no specific forced fluid flow exists in the end caps in addition to the natural fluid movement induced by the machine rotation speed.

The modeled convection exchanges, corresponds to the sum of two phenomena:

- The differences of fluid temperature existing in different volumes of the end spaces (giving a difference of fluid density) creating some fluid natural swirling in the end spaces.
- The fluid movement induced by the rotation speed of the machine.

Our internal natural convection model is based on classical correlations for end spaces, considering different fluid velocities for the parts close to the rotating parts, and far from the rotating parts.

Therefore, there is no user input to define in this mode.

Note: The natural convection mode is well adapted to model every enclosed machine without internal fans. When internal fans, or rotor fins exist, it is advised to switch to forced convection mode.

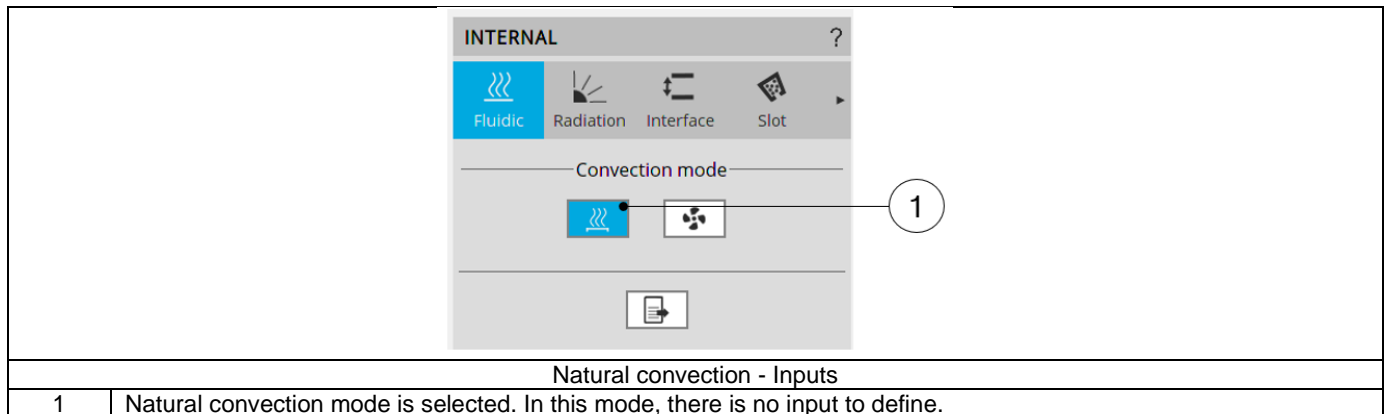

### 1.11.3.2 Forced convection

This convection mode allows forcing the convection model used for every region of the end spaces.

It can be used to model:

- Increased convection effects due to rotor fins of shaft mounted internal fans.
- A fan internally forcing constant ventilation whatever the rotation speed of the machine.
- Some forced convection coefficients in the end spaces.

The end spaces are divided in four areas, corresponding to four inputs the user must defined in forced convection mode:

- The « Upper » Connection Side region, corresponding to the Connection Side convection areas far from the rotating parts.
- The « Lower » Connection Side region, corresponding to the Connection Side convection areas close to the rotating parts.
- The « Upper » Opposite Connection Side region, corresponding to the Opposite Connection Side convection areas far from the rotating parts.
- The « Lower » Opposite Connection Side region, corresponding to the Opposite Connection Side convection areas close to the rotating parts.

When selecting one of these four inputs, the corresponding exchange areas are highlighted in the axial view of the machine. See below illustrations.



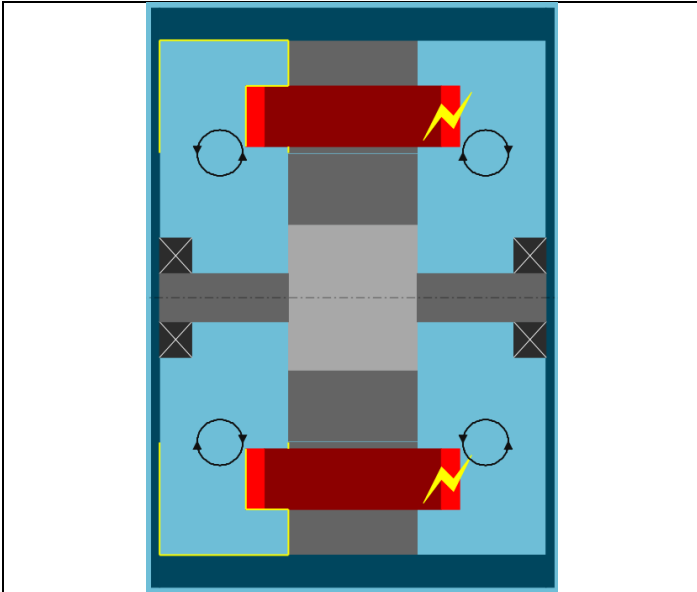

Opposite Connection Side "Upper" region – far from the rotor

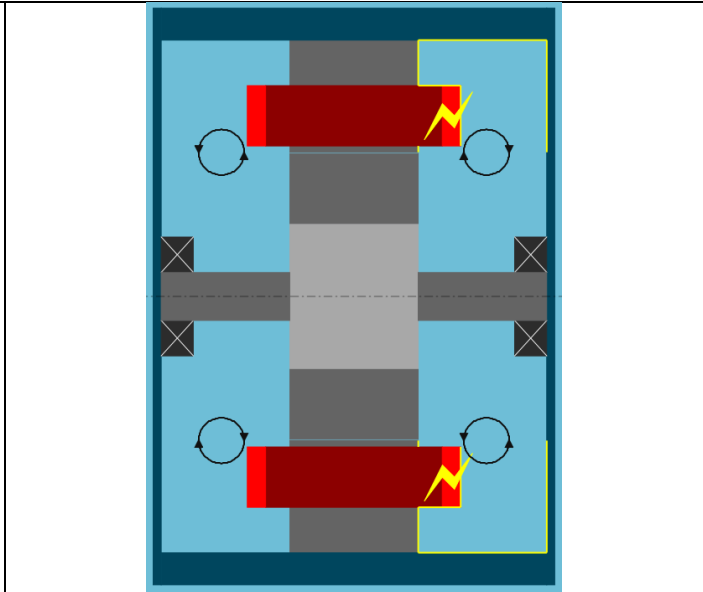

Connection Side "Upper" region – far from the rotor

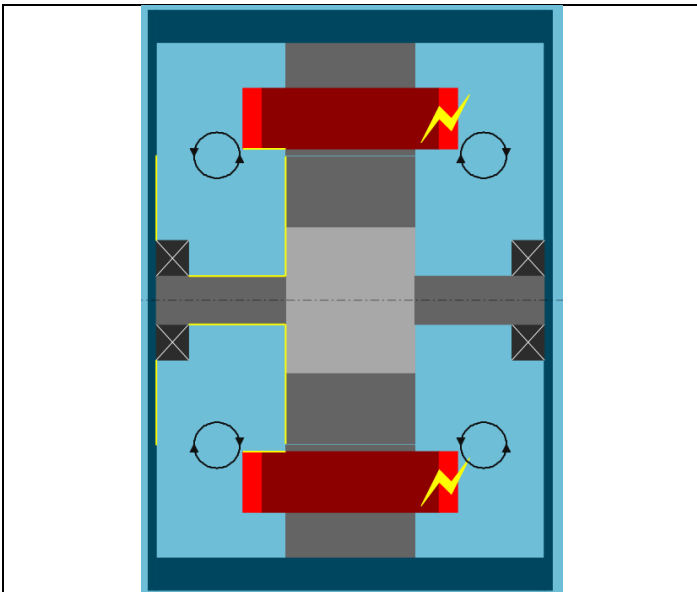

Opposite Connection Side "Lower" region – close to the rotor

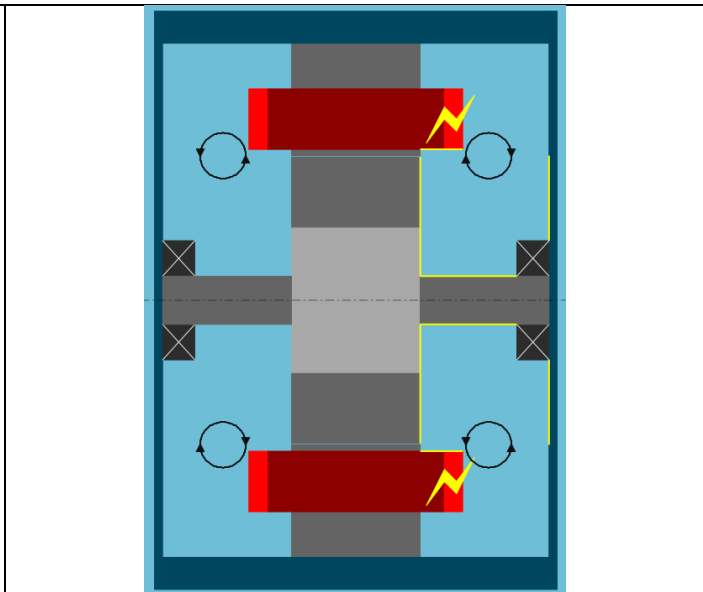

Connection Side "Lower" region – close to the rotor

For all the four represented regions, the convection can be modeled with three different input ways:

- A tip speed ratio
- A fluid speed
- A convection coefficient

The user can select the inputs mode of each region using the dedicated arrow or clicking on the input mode to change.

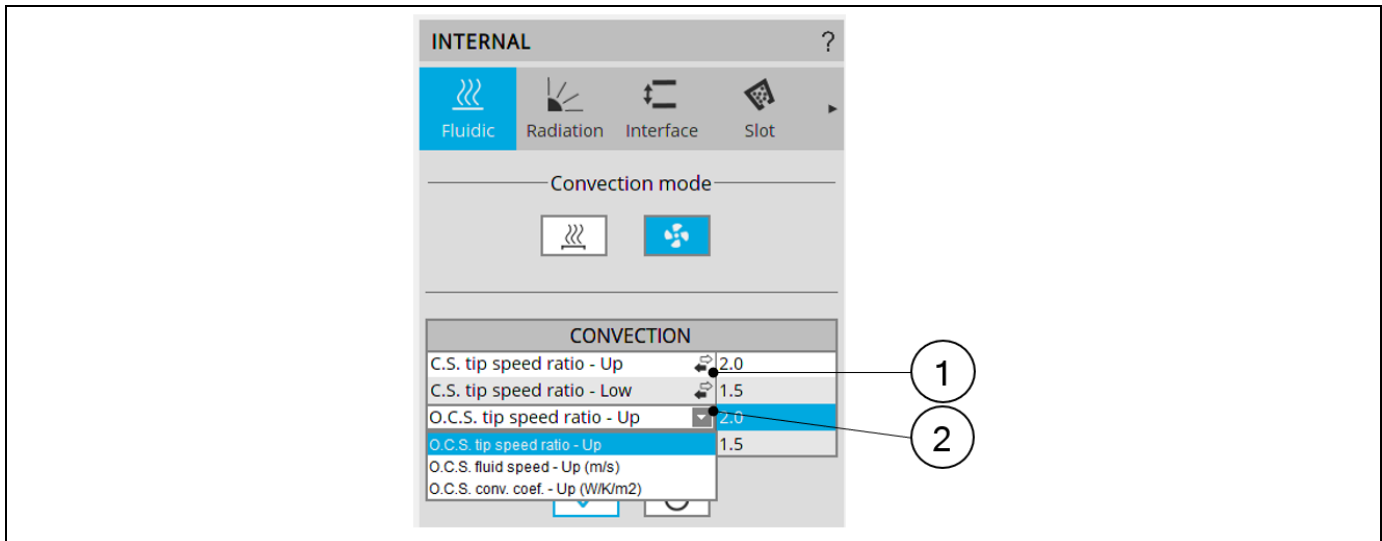

Forced convection – Selection of input modes

1	Click on the arrow, or directly on the input mode, to show the drop-down menu allowing the input mode selection
2	Drop down menu allows choosing an input mode for the dedicated convection region.

The « Tip speed ratio » input mode allows setting a fluid velocity proportional to the rotor tip speed.

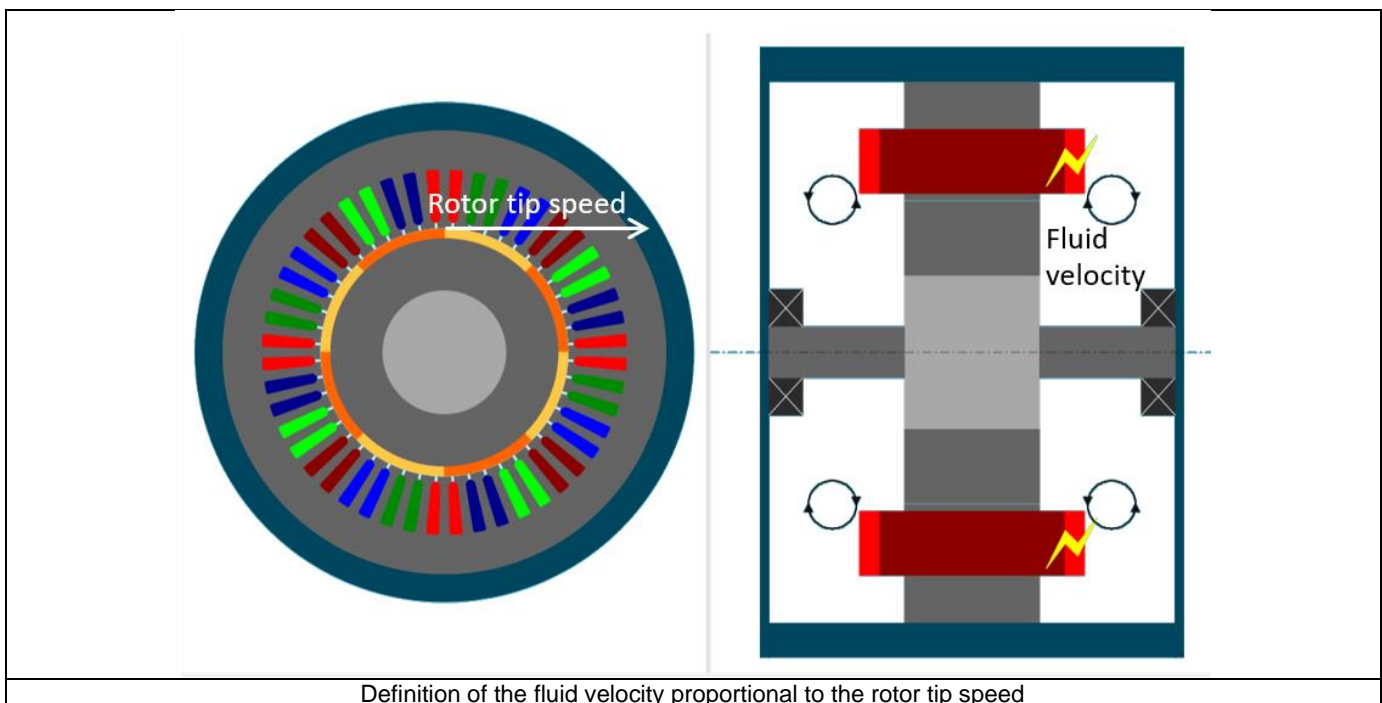

This can be used to model a shaft mounted fan, or rotor fins.

The default values of tip speed ratios are 2 for the regions far from the rotor.

A tip speed ratio of 2 for an « Upper » region (meaning a region far from the rotor) corresponds to a shaft mounted fan, or rotor fins, that blows air to this region with an average efficiency.

For « Upper » region of a side without fan or fins, it is advised to set a rotor tip speed ratio of 5. This corresponds to the FluxMotor® natural convection model.

The default value of tip speed ratio is of 1.5 for the regions close to the rotor.

In fact, for these regions, the considered fluid speed is the relative speed between the fluid velocity and the rotating parts speed, meaning that in these regions the convection is highly related to the rotation speed.

The « Constant fluid speed » input mode can be used to model a constant ventilation speed.

The «Convection coefficient » input mode allows directly forcing a convection coefficient in the corresponding region.

#### Notes:

- For any chosen input mode, the end spaces are considered as totally enclosed. No fluid exchange exists between the end space fluid (the « internal fluid ») and the « external fluid ». The cooling strategy corresponding to blow an external fluid at a fixed temperature into and through the machine cannot be modeled in the current version of FluxMotor®.
- In both input modes « Tip speed ratio » and « Constant fluid speed », the fluid speed is applied to classical correlations depending on the nature of the sub region (end winding, frame, rotor part...). In the « Convection coefficient » input mode, the same convection coefficient is applied in all sub regions (end winding, rotor end, end cap, frame...) of the regions for which the coefficient is chosen.

CONVECTION	
C.S. tip speed ratio - Up	2.0
C.S. tip speed ratio - Low	1.5
O.C.S. tip speed ratio - Up	2.0
O.C.S. tip speed ratio - Low	1.5

Forced convection - Inputs

1	Forced convection mode is selected
2	Input related to the Connection Side "Upper" region, here set as a tip speed ratio
3	Input related to the Connection Side "Lower" region, here set as a tip speed ratio
4	Input related to the Opposite Connection Side "Upper" region, here set as a tip speed ratio
5	Input related to the Opposite Connection Side "Lower" region, here set as a tip speed ratio

### 1.11.4 Radiation – Inputs

This panel allows describing the parameters defining the radiation phenomenon existing in the machine.

Mainly, two radiation phenomena exist in the machine:

- From the end windings, rotor and stator ends to the frame and the end caps.
- Between the rotor and the stator, in the airgap.

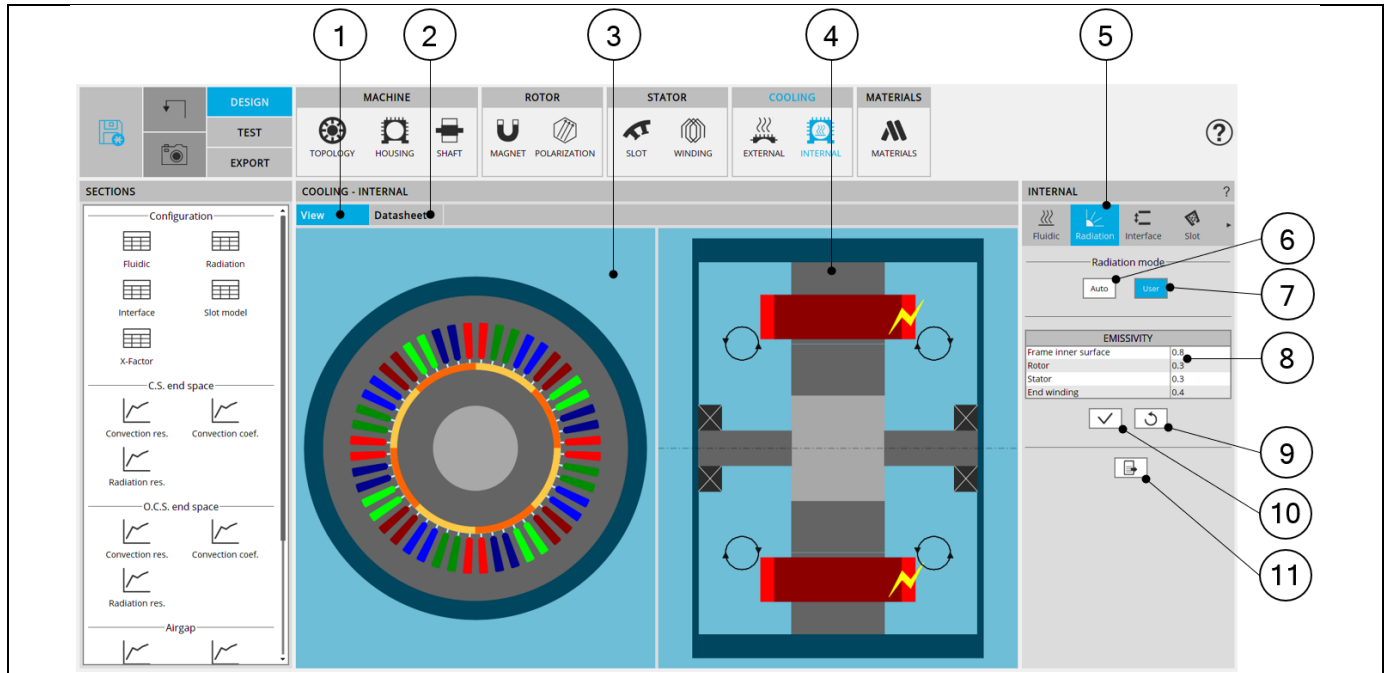

Internal cooling - Radiation design area

1	Display the axial and radial view of the machine.
2	Display the internal cooling datasheet, showing the thermal parameters defining the internal heat exchanges.
3	Radial view of the motor, where specific exchange areas can be highlighted depending on the selected input.
4	Axial view of the motor, where specific exchange areas can be highlighted depending on the selected input.
5	The section "Radiation" is selected.
6	Button to set the internal emissivity automatically by internal process
7	Selected button, to set the internal emissivities manually
8	Input related to the radiation corresponding to the selected radiation mode. In user mode, the following emissivities must be set: <ul style="list-style-type: none"> <li>• The frame inner surface emissivity, with a default value of 0.8</li> <li>• The rotor and stator emissivity, with a default value of 0.3. These emissivities are used for the radiation occurring in the airgap, and from the rotor end and stator end to each end space.</li> <li>• The end winding emissivity, with a default value of 0.4. This emissivity is applied to non-potted end-windings only. The assumption is made that the potted end-windings do not radiate any power.</li> </ul>
9	Button to restore default input values.
10	Button to apply inputs. Pressing the enter key twice applies inputs too.
11	Icon to export internal cooling data into *.txt or *.xlsx files.

### 1.11.5 Interface – Inputs

This panel allows describing imperfect contacts between the different components of the machine.

The imperfect contacts are here modeled as a parasitic airgap between two parts, through which the heat must be conducted through to go from one part to the other.

The interface gaps are composed of air at the atmospheric pressure, at 20 °C, equivalent to 293.15K. For more information on material properties, please refer to our material database (“Materials application”).

Mainly, the imperfect contacts existing in a machine are:

- Each interface/mounting of a laminated part on a solid material
  - Between the magnetic circuit and the frame
  - Between the magnetic circuit and the magnets
  - Between the magnetic circuit and the shaft
- The imperfect contact between the magnetic circuit and the liner surrounding the slot.
- The imperfect contact between the frame (straight part) and the two end caps
- The bearings: An interface gap thickness is used to compute the thermal resistance of each bearing. These values of contact thickness are used in computations for both bearings (Connection Side and Opposite Connection Side).

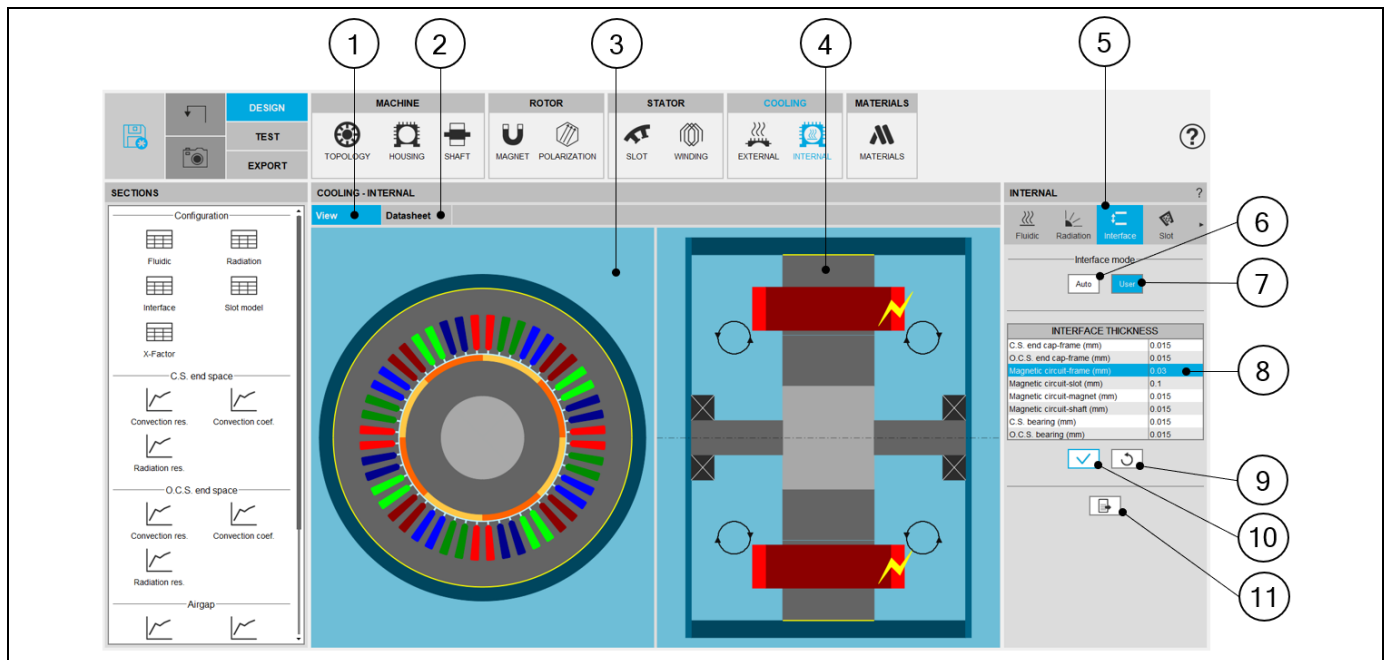

Internal cooling - Interface design area

1	Display the axial and radial view of the machine.
2	Display the internal cooling datasheet, showing the thermal parameters defining the internal heat exchanges.
3	Radial view of the motor, where specific exchange areas can be highlighted depending on the selected input.
4	Axial view of the motor, where specific exchange areas can be highlighted depending on the selected input.
5	The section “Interface” is selected.
6	Button to set the interface gaps automatically by internal process.
7	Selected button, to set user interface gaps.
8	Parasitic interface thicknesses corresponding to the selected interface mode. In user mode, the following thicknesses must be set: <ul style="list-style-type: none"> <li>• CS end cap-frame interface thickness, with a default value of 15 micrometers.</li> <li>• OCS end cap-frame interface thickness, with a default value of 15 micrometers.</li> <li>• Magnetic circuit – frame interface thickness, with a default value of 30 micrometers.</li> <li>• Magnetic circuit – slot interface thickness, with a default value of 100 micrometers. This corresponds to the imperfect contact between the liner and the iron core.</li> <li>• Magnetic circuit – magnet interface thickness, with a default value of 15 micrometers.</li> <li>• Magnetic circuit – shaft interface thickness, with a default value of 15 micrometers.</li> <li>• CS Bearings equivalent interface thickness, with a default value of 15 micrometers.</li> <li>• OCS Bearings equivalent interface thickness, with a default value of 15 micrometers.</li> </ul>
9	Button to restore default input values.
10	Button to apply inputs. Pressing the enter key twice applies inputs too.
11	Icon to export internal cooling data into *.txt or *.xlsx files.

### 1.11.6 Slot model – Inputs

The thermal exchanges from the conductors to the stator core are complex phenomena for which FluxMotor® embeds a dedicated model.

This panel allows choosing the conduction model from the conductors to the stator core.

By default, a FluxMotor® model is proposed. This model uses the slot fill factor, the conductor shape, and the conductivities of the materials inside the slot, to compute two equivalent conductivities:

- The radial and orthoradial conductivity of the winding, used to compute thermal exchanges from the winding to the stator core.
- The axial conductivity of the winding used to compute thermal exchanges from the in-slot winding to the end windings.

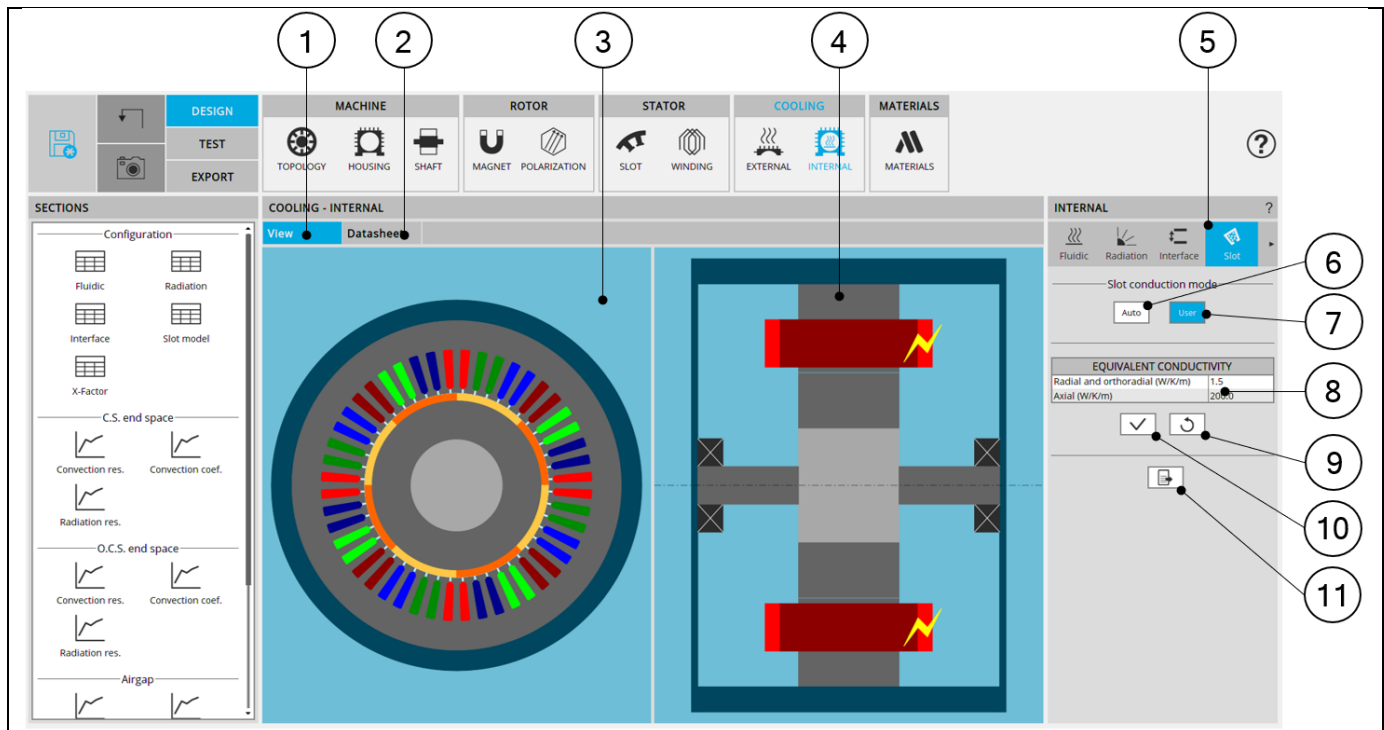

Internal cooling – slot model design area

1	Display the axial and radial view of the machine.
2	Display the internal cooling datasheet, showing the thermal parameters defining the internal heat exchanges.
3	Radial view of the motor, where specific exchange areas can be highlighted depending on the selected input.
4	Axial view of the motor, where specific exchange areas can be highlighted depending on the selected input.
5	The section "Slot model" is selected.
6	Button to set the slot conductivities automatically by internal process.
7	Selected button, to set the user slot conductivities.
8	Equivalent conductivities, to be set only when the User mode has been chosen. In user mode, the following inputs must be set: <ul style="list-style-type: none"> <li>• The radial and orthoradial conductivity of the winding, used to compute thermal exchanges from the winding to the stator core. The default value is 1.5 W/ (K.m).</li> <li>• The axial conductivity of the winding used to compute thermal exchanges from the in-slot winding to the end windings. The default value is 200 W/ (K.m)</li> </ul>
9	Button to restore default input values.
10	Button to apply inputs. Pressing the enter key twice applies inputs too.
11	Icon to export internal cooling data into *.txt or *.xlsx files.

### 1.11.7 X-Factors

The X-Factor panel allows the user to defined calibration factors to tune the thermal modeling on specific resistances.

The calibration factors set in this panel are considered in the results shown in COOLING subset, INTERNAL panel environment, and in the TEST environment.

The X-Factor panel also contains a set of parameters defining the internal cooling (coolants temperature and rotor speed) allowing the user to evaluate the thermal model embedded.

The effect on every X-Factor value can be directly seen in the outputs displayed in internal cooling panel.

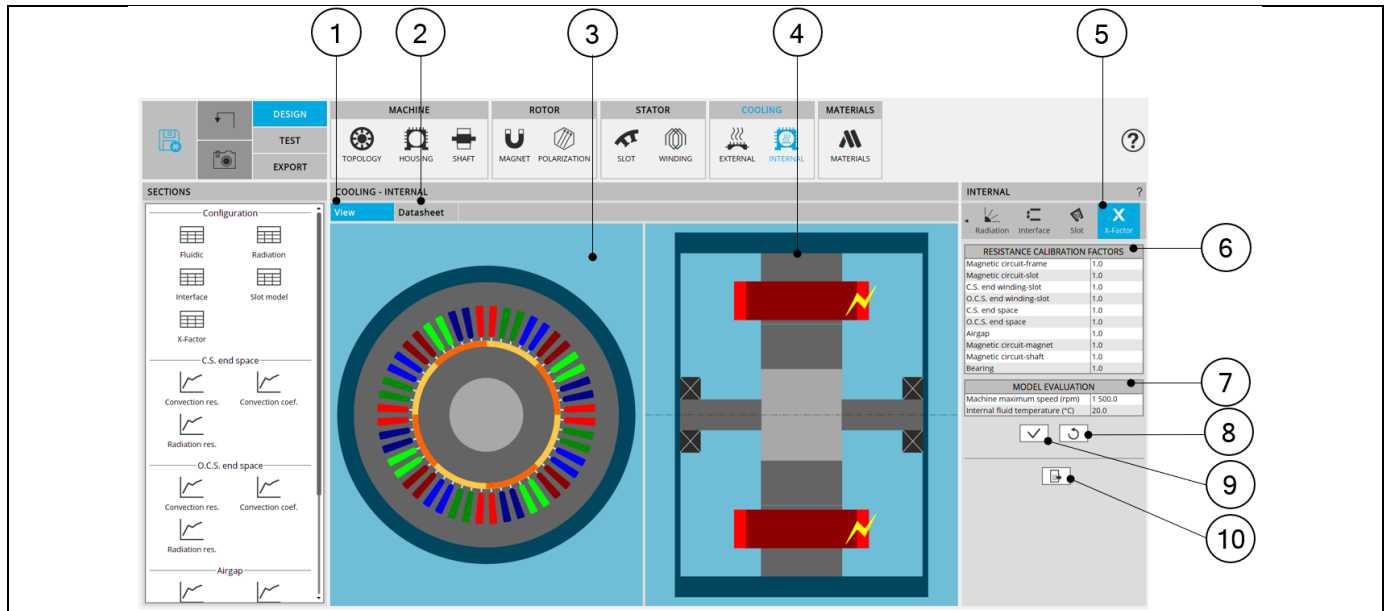

Internal cooling – X-Factor design area

1	Display the axial and radial view of the machine.
2	Display the internal cooling datasheet, showing the thermal parameters defining the internal heat exchanges.
3	Radial view of the motor, where specific exchange areas can be highlighted depending on the selected input.
4	Axial view of the motor, where specific exchange areas can be highlighted depending on the selected input.
5	The section X-Factors is selected.
6	Table of the calibration factors allowing the user to tune the thermal modeling. Each X-factor tunes a set of resistances. The mapping showing the impact of each X-factor is explained in the below dedicated section.
7	Input table used for the evaluation of the internal cooling, defining the results displayed in the internal cooling datasheet.
8	Button to restore default input values.
9	Button to apply inputs. Pressing the enter key twice applies inputs too.
10	Icon to export internal cooling data into *.txt or *.xlsx files.

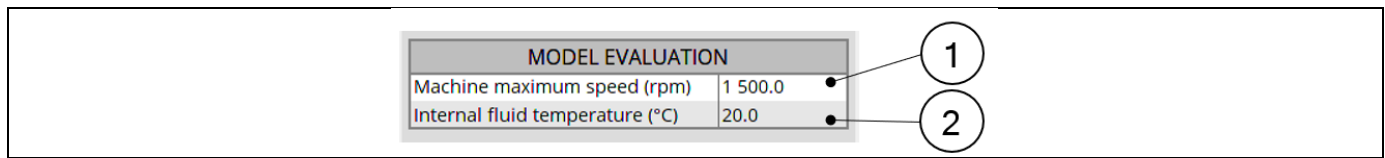

External cooling – Model evaluation input table

1	Machine maximum speed. It is the maximum rotation speed for which the convection curves will be evaluated in the internal cooling datasheet.
2	Internal fluid temperature It is the temperature used in internal cooling panel to evaluate the convection and the radiation occurring inside the machine. All the results shown in internal cooling panel used this temperature as the temperature of the internal fluid enclosed in the machine. Most of the curves shown in Internal cooling panel are plotted for a range of temperature going from this reference temperature to 150 Kelvin above it.  Note: This temperature is only used for the model evaluation in the internal cooling panel. This temperature does not affect the test computations, where the internal fluid temperature is found by the nonlinear solving during the solving of the test.

## 1.11.7.1 X-Factor mapping

Each calibration factor impacts a specific set of resistances, among the most important thermal resistances of the thermal modeling of a machine.

RESISTANCE CALIBRATION FACTORS	
1	Magnetic circuit-frame 1.0
2	Magnetic circuit-slot 1.0
3	C.S. end winding-slot 1.0
4	O.C.S. end winding-slot 1.0
	C.S. end space 1.0
	O.C.S. end space 1.0
	Airgap 1.0
	Magnetic circuit-magnet 1.0
	Magnetic circuit-shaft 1.0
	Bearing 1.0

Internal cooling – Calibration factors input table – Part 1

1	<p>Magnetic circuit-frame.</p> <p>This calibration factor tunes the total resistance between the stator yoke and the frame. This total resistance is composed of two resistances in series:</p> <ul style="list-style-type: none"> <li>The conduction through the stator yoke until its border, computed by finite elements</li> <li>The conduction through the imperfect interface between the stator magnetic circuit and the frame</li> </ul>
2	<p>Magnetic circuit-slot.</p> <p>This calibration factor tunes each of the thermal resistances linking the stator core to the winding. Each of these resistances consists of several resistances in series:</p> <ul style="list-style-type: none"> <li>The conduction through the stator core until the slot border, computed by finite elements</li> <li>The conduction through the imperfect interface between the magnetic circuit and the liner</li> <li>The conduction through the slot (using the equivalent conductivity defined in the settings “Slot model” of the “Internal cooling” panel).</li> </ul>
3	<p>Connection Side end winding – slot.</p> <p>This calibration factor tunes the conduction resistance between the slots (meaning In-slot winding) to the Connection Side end winding.</p>
4	<p>Opposite Connection Side end winding – slot. This calibration factor tunes the conduction resistance between the slots (meaning In-slot winding) to the Opposite Connection Side end winding.</p>



RESISTANCE CALIBRATION FACTORS	
Magnetic circuit-frame	1.0
Magnetic circuit-slot	1.0
C.S. end winding-slot	1.0
O.C.S. end winding-slot	1.0
C.S. end space	1.0
O.C.S. end space	1.0
Airgap	1.0
Magnetic circuit-magnet	1.0
Magnetic circuit-shaft	1.0
Bearing	1.0

Internal cooling – Calibration factors input table – Part 2

5	<p>Connection Side end space. This calibration tunes all the resistances involved in thermal exchanges with or through the Connection Side end space fluid:</p> <ul style="list-style-type: none"> <li>• The thermal resistances from each part composing the stator and the rotor to the Connection Side end space fluid (each of these resistances being composed of conduction through the machine depth added to convection at the rotor and stator ends)</li> <li>• The convection resistance between the Connection Side end winding and the Connection Side end space fluid.</li> <li>• The thermal resistance between the Connection Side end space fluid and the frame and end cap surfaces on the Connection Side.</li> <li>• The radiation resistances from the stator end, rotor end, and end winding, to the frame and the end cap surfaces on the Connection Side.</li> </ul>
6	<p>Opposite Connection Side end space. This X-factor tunes every resistance involved in thermal exchanges with or through the Opposite Connection Side end space fluid:</p> <ul style="list-style-type: none"> <li>• The thermal resistances from each part composing the stator and the rotor to the Opposite Connection Side end space fluid (each of these resistances being composed of conduction through the machine depth added to convection at the rotor and stator end)</li> <li>• The convection resistance between the Opposite Connection Side end winding and the Opposite Connection Side end space fluid.</li> <li>• The thermal resistance between the Opposite Connection Side end space fluid and the frame and end cap surfaces on the Opposite Connection Side.</li> <li>• The radiation resistances from the stator end, rotor end, and end winding, to the frame and the end cap surfaces on the Opposite Connection Side.</li> </ul>

RESISTANCE CALIBRATION FACTORS	
Magnetic circuit-frame	1.0
Magnetic circuit-slot	1.0
C.S. end winding-slot	1.0
O.C.S. end winding-slot	1.0
C.S. end space	1.0
O.C.S. end space	1.0
Airgap	1.0
Magnetic circuit-magnet	1.0
Magnetic circuit-shaft	1.0
Bearing	1.0

Internal cooling – Calibration factors input table – Part 3

7	<p><b>Airgap.</b> This calibration factor tunes every resistance involved in thermal exchanges with or through the airgap fluid:</p> <ul style="list-style-type: none"> <li>• The conduction through the stator yoke and slot until the airgap border, computed by finite elements</li> <li>• The conduction through the rotor yoke and magnets until the airgap border, computed by finite elements</li> <li>• The convection from the airgap border to the airgap fluid.</li> <li>• The radiation from every rotor component having a border along the airgap, to every stator component having a border along the airgap</li> </ul>
8	<p><b>Magnetic circuit-magnet.</b> For every existing magnet, this calibration factor tunes the total resistance existing between this magnet and every component of the rotor magnetic circuit around it. Each of these resistances are composed of three resistances:</p> <ul style="list-style-type: none"> <li>• The conduction through the rotor yoke until the magnet border, computed by finite elements</li> <li>• The conduction through the imperfect interface between the rotor magnetic circuit and the considered magnet.</li> <li>• The conduction through the magnet until its border, computed by finite elements</li> </ul>
9	<p><b>Magnetic circuit-shaft.</b> This calibration factor tunes the total resistance between the rotor yoke and the shaft. This total resistance is composed of two resistances in series:</p> <ul style="list-style-type: none"> <li>• The conduction through the rotor yoke until its border, computed by finite elements</li> <li>• The conduction through the imperfect interface between the rotor magnetic circuit and the shaft</li> </ul>
10	<p><b>Bearings.</b> This calibration factor tunes the resistances existing across the Connection Side bearing and the Opposite Connection Side bearing. These resistances are the resistances computed directly from the bearing equivalent airgap thickness set by the user in INTERFACE settings.</p>

The following picture gives an example of a simple thermal circuit, including the main resistances corresponding to the default synchronous magnet machine, where a frame, a shaft and bearings have been added.

The numbers on every resistance show what X-factor impacts this resistance value.

To keep the scheme simple, the radiation resistances are not represented there.

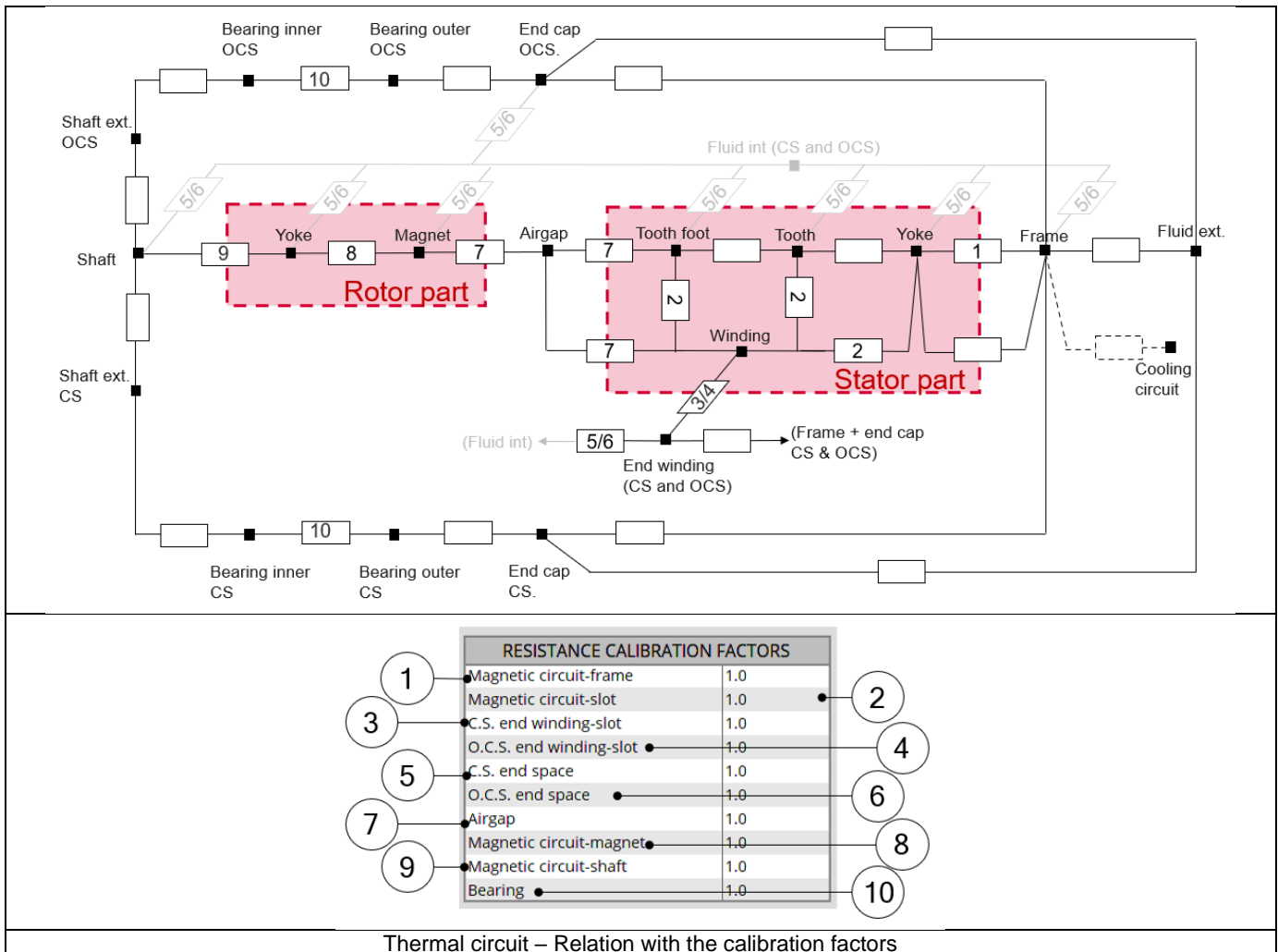

### 1.11.8 Internal cooling outputs

#### 1.11.8.1 End-space

Three plots exist for each end space, showing the convection coefficients and resistances in the end space, and the radiation resistances through the end space. The result structure is the same for Connection Side and Opposite Connection Side.

##### 1) End-space convection (Coefficient and resistance)

These curves show the convection coefficients and resistances existing for each component having an exchange surface with the considered end space:

- The frame inner surface (including the surfaces of the end cap and of the straight extension of the frame)
- The stator and rotor ends
- The end winding
- The shaft

The curves are plotted for a range of rotor speed going from zero to the maximum speed set by the user in the X-Factor settings of COOLING subset, INTERNAL panel, and for the temperature of the internal fluid specified in the X-Factor settings.

##### 2) End space radiation

These curves show the radiation resistances existing in the considered end space:

- From the end winding to the frame. This resistance exists only when the end winding is not potted on the considered side.
- From the rotor end to the frame.

No radiation resistance is considered from the stator ends to the frame, the end winding blocking the radiations between both surfaces. These curves are plotted for active part temperatures going from the internal fluid temperature set by the user in X-Factor subset of COOLING subset, INTERNAL panel, to 150 Kelvin above this reference temperature.

#### 1.11.8.2 Airgap

##### 1) Airgap convection (Coefficient and resistance)

These curves give an overview of the total convection resistances existing when summing all exchange areas on the borders on the rotor side, and on the stator side. Two curves exist, showing the total convection resistance from the stator border and the airgap fluid, and from the rotor border to the airgap fluid.

The curves are plotted for a range of rotor speed going from zero to the maximum speed set by the user in the X-Factor settings of COOLING subset, INTERNAL panel, and for the temperature of the internal fluid specified in the X-Factor settings.

##### 2) Airgap radiation

This curve shows an estimation of the overall radiation resistance between the stator and the rotor. To plot this curve, one of the borders is considered at the temperature of the internal fluid specified in the X-Factor settings, and the temperature of the hottest border take a range of temperature value from this reference temperature until 150 Kelvin above it.

#### 1.11.8.3 Interface conduction resistances

This table shows the thermal resistances equivalent to the interface thicknesses set in the Interface settings.

Note: The resistances computed here do not consider the conduction through the material around the gaps. For instance, the resistance « magnetic circuit-frame » computed here does not consider the conduction through the stator magnetic circuit or through the frame, but only the thermal resistance corresponding to the conduction through the parasitic thickness of air contained between the magnetic circuit and the frame.

#### 1.11.8.4 Slot model characteristic

This table reminds to the user the slot fill factors and the thermal conductivities of the material composing the winding and the insulation, and then shows the equivalent axial and radial thermal conductivities of the slot.

The shown conductivities depend on the input mode selected by the user in Slot model settings.

In automatic mode, it is the conductivities computed by the FluxMotor® model.

In user mode, these are the conductivities set manually by the user.

The thermal resistance between the in-slot winding and each of the end windings is computed at the end of the table, based on the slot axial equivalent conductivity.

## 1.12 Materials

### 1.12.1 Overview

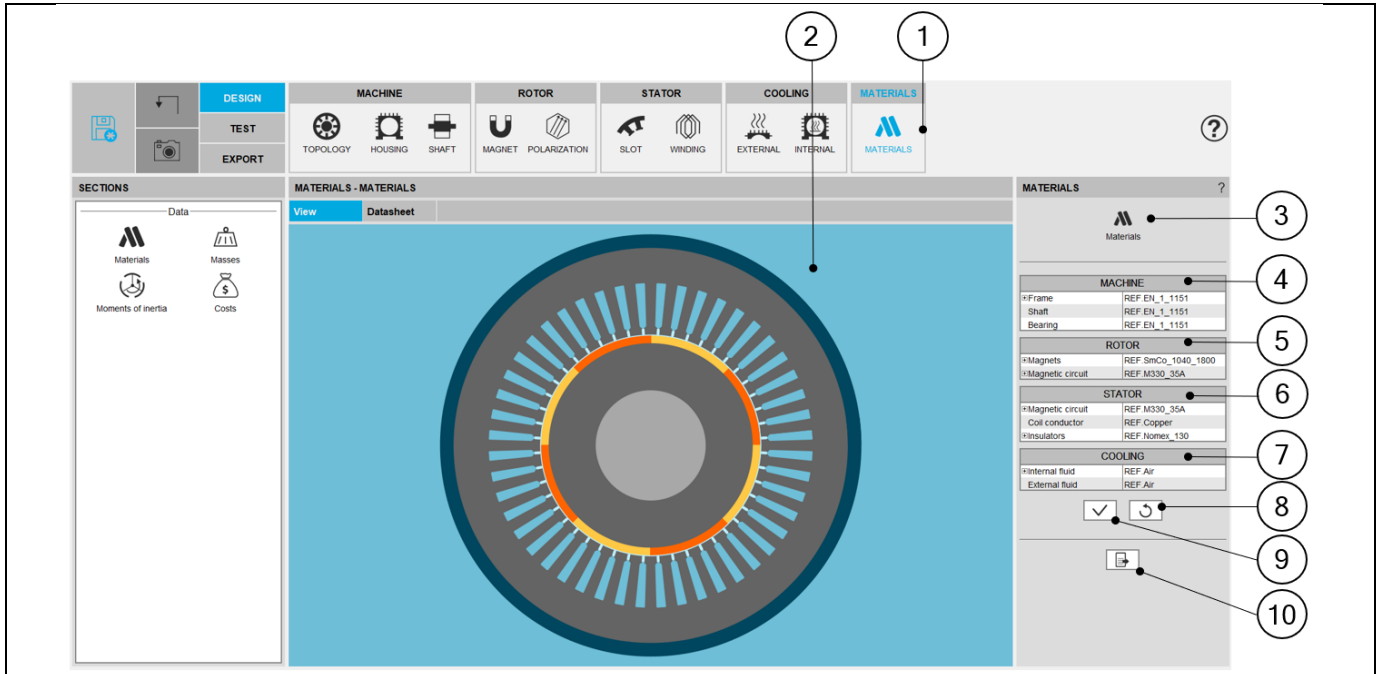

MATERIALS design area

1	Selection of the Material subset: MATERIALS panel (Click on the icon MATERIALS)
2	Visualization of the machine regions.
3	Direct access to open material manager. It allows seeing properties of materials.
4	Area to assign materials to machine regions (frame, shaft, bearings). See additional information below.
5	Area to assign materials to rotor regions (magnets, magnetic circuit). See additional information below.
6	Area to assign materials to Stator regions (magnetic circuit, coil conductor, insulators). See additional information below.
7	Area to assign materials to Cooling fluids (internal fluid, external fluid). See additional information below.
8	Button to restore default materials. Default materials are those defined as favorite materials in Material manager. See "Materials" application for more information.
9	Button to validate assignment of materials. Pressing the Enter key twice applies inputs too.
10	Icon to export material data into *.txt or *.xlsx files.

## 1.12.2 Rotor inputs / outputs

The screenshot shows the software interface for assigning materials to the rotor. The interface is divided into several sections: MACHINE, ROTOR, STATOR, and COOLING. The ROTOR section is expanded to show a list of magnets and their assigned materials. A yellow region on the rotor is highlighted, and the material list for Magnet1A is expanded to show a selection of NdFeB materials. A checkmark button is visible at the bottom of the material list.

MACHINE	
Frame	REF.EN_1_1151
Shaft	REF.EN_1_1151
Bearing	REF.EN_1_1151

ROTOR	
⊖ Magnets	REF.NdFeB_1050_2800
Magnet1A	REF.NdFeB_1050_28...
Magnet2A	REF.NdFeB_1050_2800
Magnet1B	REF.NdFeB_1110_2500
Magnet2B	REF.NdFeB_1230_1400
⊕ Magnetic circuit	REF.NdFeB_1320_1400
	REF.NdFeB_1370_1273

STATOR	
⊕ Magnetic circuit	REF.SmCo_1040_1800
	REF.SmCo_1100_1800
Coil conductor	REF.Copper
⊕ Insulators	REF.Nomex_130

COOLING	
⊖ Internal Fluid	REF.Air
Airgap	
Edge	
External Fluid	REF.Air

## Assign MAGNETS to the rotor

1	Expand the section dedicated to magnets. Several magnet materials can be assigned to the same rotor pole. Here four magnets are defined. Different magnet materials can be assigned to each of them.
2	By selecting a region name (Magnet1A for example) the corresponding face region is highlighted.
3	Expand the material list to choose a magnet material for assigning to the selected magnet.
4	Button to restore default materials. Default materials are those defined as favorite materials in Material manager. See "Materials" application for more information.
5	Button to validate assignment of materials. Pressing the Enter key twice applies inputs too.

## 1.12.3 How to assign materials – Example for rotor lamination

MACHINE	
Frame	REF.EN_1_1151
Shaft	REF.EN_1_1151
Bearing	REF.EN_1_1151
ROTOR	
⊞ Magnets	REF.NdFeB_1050_2800
⊞ Magnetic circuit	REF.M330_35A
Yoke	
Bridge	
Interpole	
Web	
Pole shoe	
STATOR	
⊞ Magnetic circuit	REF.M330_35A
Coil conductor	REF.Copper
⊞ Insulators	REF.Nomex_130
COOLING	
⊞ Internal Fluid	REF.Air
Airgap	
Edge	
External Fluid	REF.Air

## Assign materials to the rotor magnetic circuit

1	Expand the section dedicated to the magnetic circuit. Different materials (LAMINATION type or SOLID type) can be assigned to it.
2	The magnetic circuit can be subdivided into several parts. (Yoke, Bridge, Web etc.)
3	By selecting a region name (Yoke for example) the corresponding face region is highlighted.
4	Expand the material list to choose a material to assign to the magnetic circuit. Only one material can be assigned to the rotor magnetic circuit. In our example it is not possible to assign different materials to sub regions like Yoke and Web.
5	Button to restore default materials. Default materials are those defined as favorite materials in Material manager. See "Materials" application for more information.
6	Button to validate assignment of materials. Pressing the enter key twice applies inputs too.

## 1.12.4 How to assign materials – Example for stator lamination

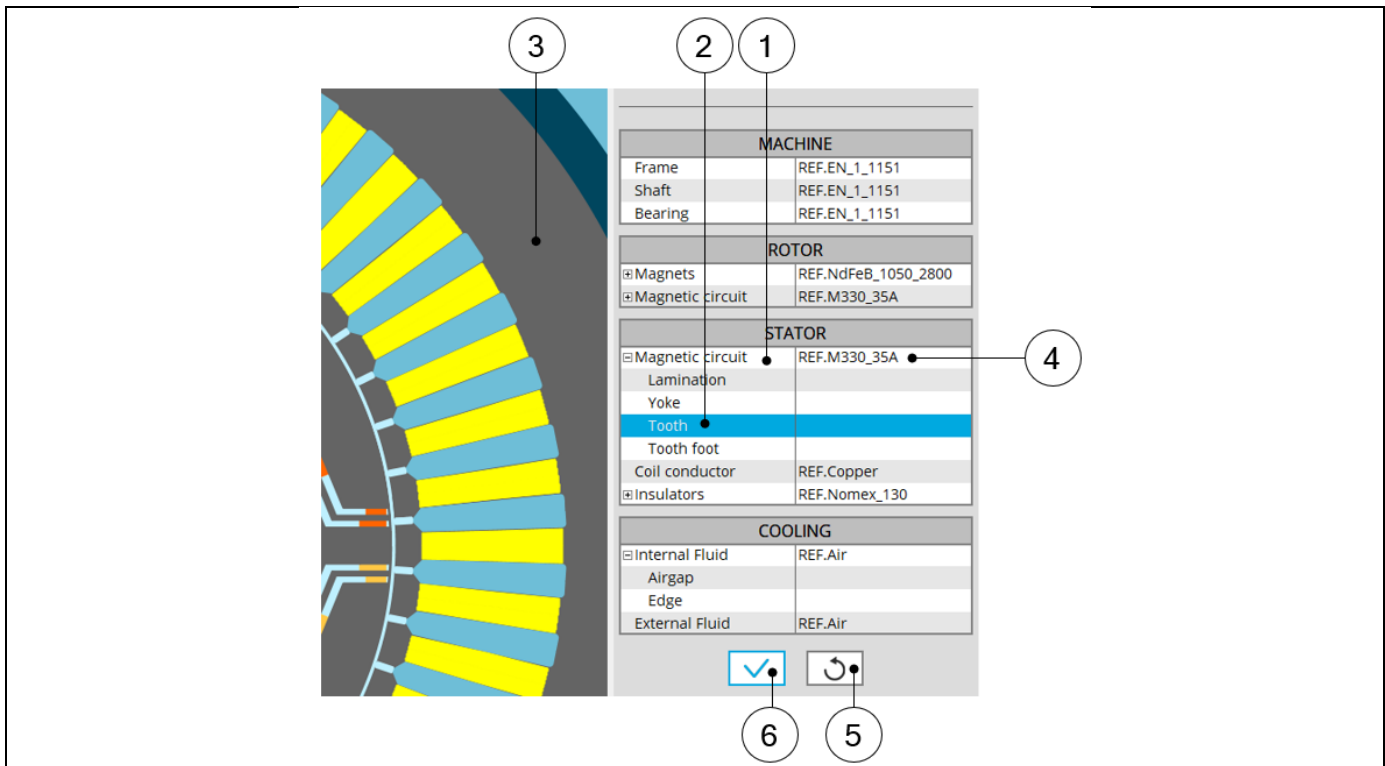

## Assign materials to the stator magnetic circuit

1	Expand the section dedicated to the magnetic circuit. Different materials (LAMINATION type or SOLID type) can be assigned to it.
2	The magnetic circuit of the stator can be subdivided into several parts (Yoke, Tooth, Tooth foot etc.).
3	By selecting a region name (Tooth for example) the corresponding face region is highlighted.
4	Expand the material list to choose a material to assign to the magnetic circuit. Only one material can be assigned to the stator magnetic circuit. In our example, it is not possible to assign different materials to sub regions like Yoke, Tooth and Tooth foot for example.
5	Button to restore default materials. Default materials are those defined as favorite materials in Material database. See "Materials" application for more information.
6	Button to validate assignment of materials. Pressing the enter key twice applies inputs too.

For more information about the rules leading to the building of parts like slots, please refer to Part Factory application.



### 1.12.5 Materials for the winding

All the materials are selected in the material database.

Conductor materials are selected in the “Electrical Conductor” type material family.

Insulator materials are selected in the “Electrical Insulator” type material family.

Thicknesses of insulations are defined inside the winding settings panel – COIL tab.

Insulation materials are considered only if a corresponding thickness is defined.

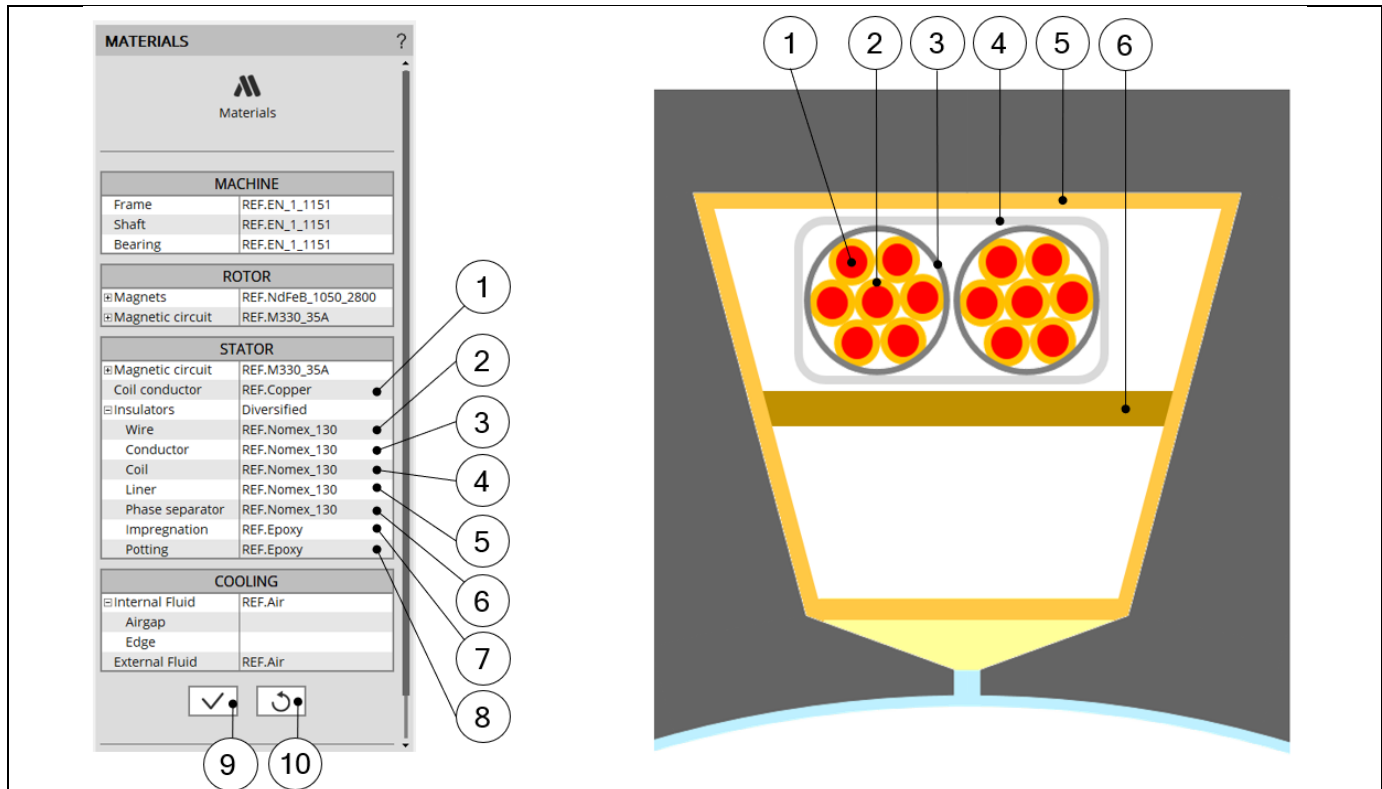

Building the winding architecture – **Choice of winding MATERIALS** - Conductor and insulation

1	Conductor materials
2	Wire insulation
3	Conductor insulation
4	Coil insulation
5	Liner
6	Phase separator
7	Impregnation inside the slot
8	Material used for encapsulating the end-windings (potting)
9	Button to validate assignment of materials. Pressing the enter key twice applies inputs too.
10	Button to restore default materials. Default materials are those defined as favorite materials in Material database. See “Materials” application for more information.
*	Insulators: If all the above choices are same material, then the corresponding material name is written in the insulators field. Otherwise “Diversified” is written in the insulators field which means there are different materials.

1.12.6 Material datasheet

**MATERIALS - MATERIALS**

View: Datasheet

Materials					
<b>Machine</b>					
Frame	REF.EN_1_1151	Shaft	REF.EN_1_1151	Bearing	REF.EN_1_1151
<b>Rotor</b>					
Magnets	REF.NdFeB_1...	Magnetic circuit	REF.M330_35A		
<b>Rotor - Magnets</b>					
Magnet1A	REF.NdFeB_1...	Magnet2A	REF.NdFeB_1...	Magnet1B	REF.NdFeB_1...
Magnet2B	REF.NdFeB_1...				
<b>Stator</b>					
Magnetic circuit	REF.M330_35A	Coil conductor	REF.Copper	Insulators	Diversified
<b>Stator - Insulators</b>					
Wire	REF.Nomex_130	Conductor	REF.Nomex_130	Coil	REF.Nomex_130
Liner	REF.Nomex_130	Phase separator	REF.Nomex_130	Impregnation	REF.Epoxy
Potting	REF.Epoxy				
<b>Cooling</b>					
Internal Fluid	REF.Air	External Fluid	REF.Air		

Masses					
Total					
Total (kg)	78.021	Rotor (kg)	15.992	Stator (kg)	62.029
<b>Rotor</b>					
Shaft (kg)	4.895	Bearing (kg)	9.11 E-1	Magnets (kg)	7.803 E-1
Magnetic circuit (kg)	9.405				
<b>Rotor - Magnets</b>					
Magnet1A (kg)	3.315 E-1	Magnet2A (kg)	1.144 E-1	Magnet1B (kg)	2.486 E-1
Magnet2B (kg)	8.576 E-2				
<b>Stator</b>					
Magnetic circuit (kg)	24.133	Frame (kg)	26.727	Winding (kg)	11.169
Stator - Winding					
Electrical conductor (kg)	10.974	Total insulation (kg)	1.948 E-1		

MATERIALS design area

1	Selection of the STATOR subset: MATERIALS panel (Click on the icon MATERIALS)
2	Shortcuts to reach material datasheet sections
3	Material datasheet where materials, masses, moment of inertia and costs are displayed
4	Icon to export stator material data into *.txt or *.xlsx files.

## 2 SYNCHRONOUS MACHINES – PERMANENT MAGNETS – OUTER ROTOR

### 2.1 Home page view

The Motor Factory – DESIGN area is the first environment of Motor Factory. It is composed of four main zones. This is the guideline to design your machine.

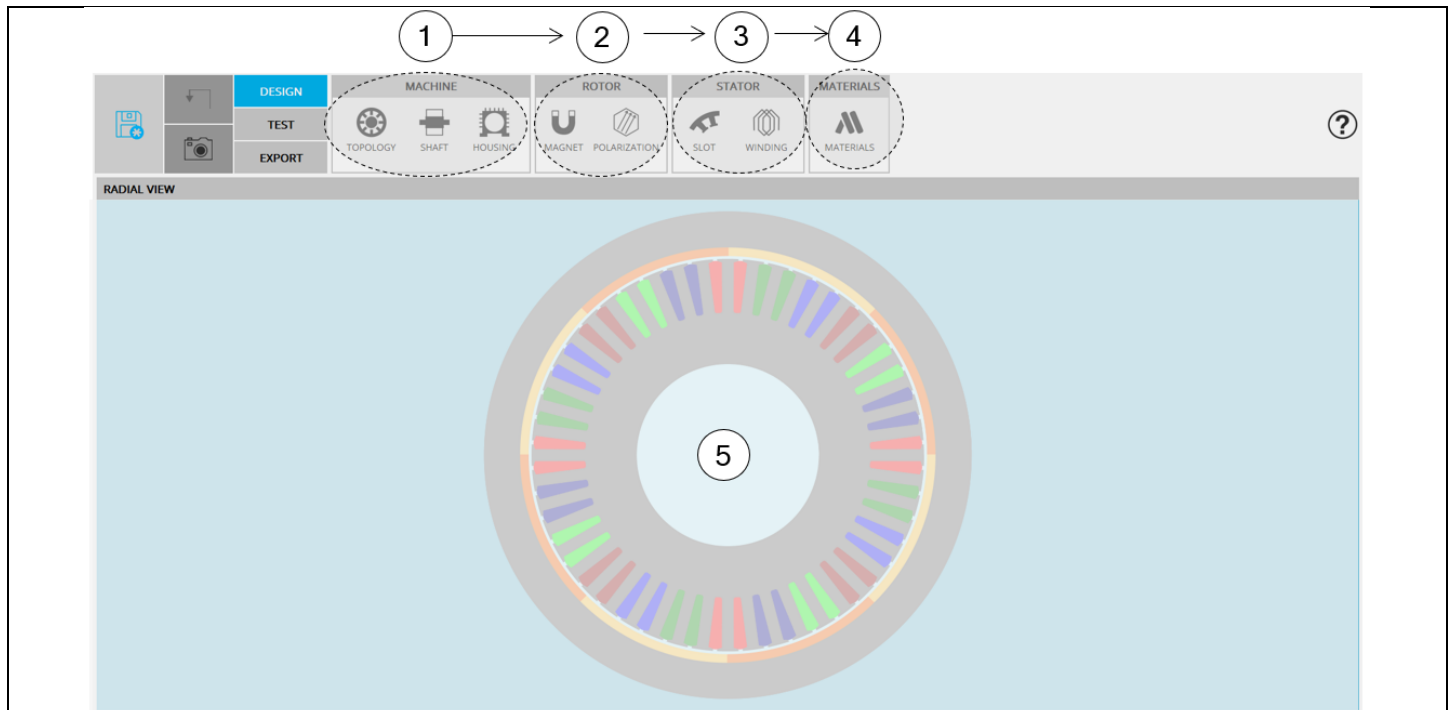

Zones of Motor Factory – DESIGN area view

Zone 1 <b>MACHINE</b>	Definition of general data of the machine depending on the considered type of machine <ul style="list-style-type: none"> <li>• Topology with overall dimensions, No. slots, No. poles</li> <li>• Shaft, type and dimensions</li> <li>• Housing</li> </ul>
Zone 2 <b>ROTOR</b>	Access this main functions to design the ROTOR and its corresponding subsets: <ul style="list-style-type: none"> <li>• Magnet and Polarization</li> </ul>
Zone 3 <b>STATOR</b>	Access this main functions to design the STATOR and its corresponding subsets: <ul style="list-style-type: none"> <li>• Slot and Winding</li> </ul>
Zone 4 <b>MATERIALS</b>	Area to select all the materials needed to build the machine, rotor, and stator.
Zone 5 <b>VIEW</b>	Visualization of the motor radial view. The winding (automatically defined) is shown. Note: Graphic functions like export picture and zoom are available on this view by right clicking on mouse (right part of the panel). See system functions, graphic management to get more information.

## 2.2 Topology

### 2.2.1 Overview

The first step of the design consists of defining structural data of the machine. However, at any time, it is possible to reach and modify the structural data from the Motor Factory design environment. Here is the process to modify the structural data from the general data panel.

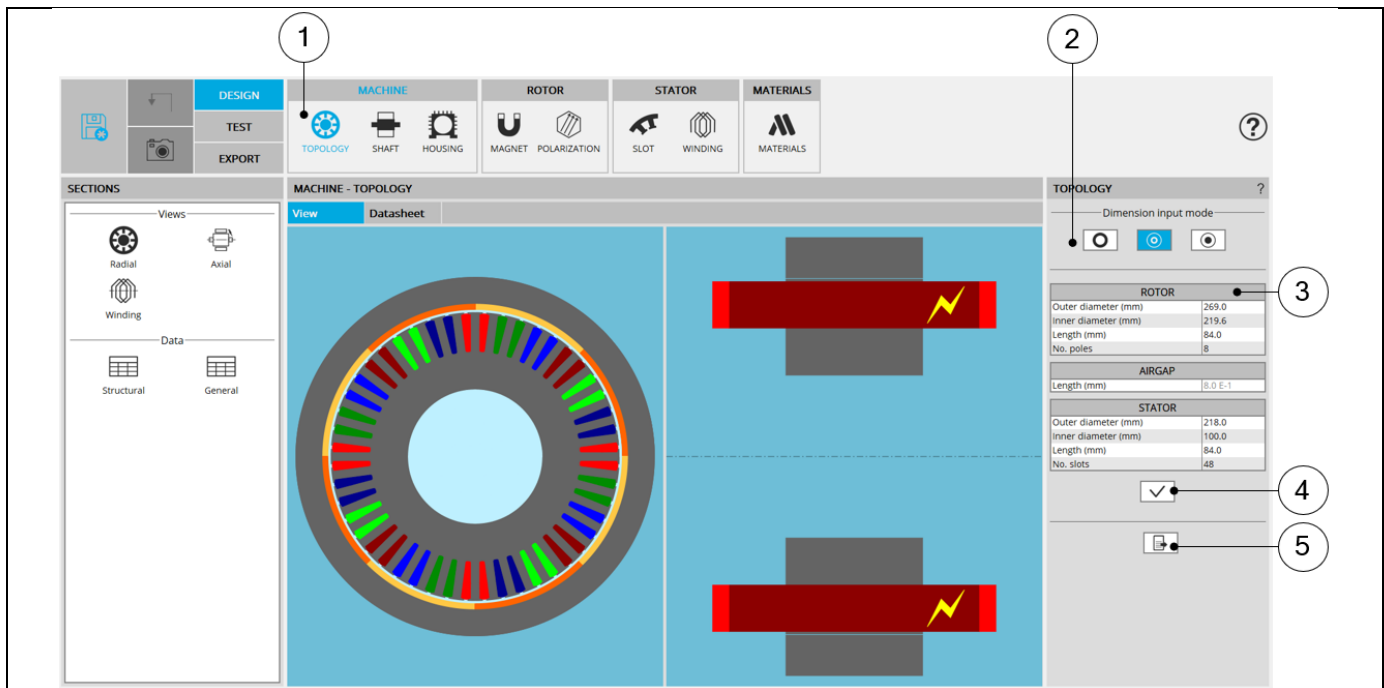

Process to reach and modify the structural data

1	Open the TOPOLOGY panel (Click on the icon TOPOLOGY)
2	Choose a way to define the diameters of the machine and the airgap See below illustration
3	Modify the values of structural data – When relevant the corresponding arrow is displayed on the view
4	Button to apply inputs
5	Icon to export data into a *.txt or *.xlsx files - Please see above illustration

For more details concerning general functions of Motor Factory Design environment, please refer to the document "MotorFactory\_2022.3\_Introduction".

## 2.2.2 Inputs

### 2.2.2.1 Method to define the airgap

In the topology sub area, three ways are possible to define the structural data of the machine, with the diameters and the airgap. They are illustrated below.

Method to define the diameters of machine and the airgap  
Example for a Synchronous Machine with Permanent Magnets and Outer Rotor

1	User defines the inner diameter of the stator and the airgap. The outer diameter of the rotor is automatically deduced (automatically computed value is displayed in grey color).
2	User defines the inner diameter of the stator and the outer diameter of the rotor. The airgap is automatically deduced (automatically computed value is displayed in grey color).
3	User defines the outer diameter of the rotor and the airgap. The inner diameter of the stator is automatically deduced (automatically computed value is displayed in grey color).

### 2.2.2.2 Structural data

Here are the user input parameters to define then structural data of the machine:

- Rotor outer diameter
- Rotor inner diameter
- Rotor length
- Number of poles
- Airgap length
- Stator outer diameter
- Stator inner diameter
- Stator length
- Number of slots

The modification of the structural data can lead to the modification of the user input parameters in defining dimensions of parts like slots or magnets. When modifications occur, a warning is displayed.

The application range for structural data are defined below.

### 2.2.3 Advice for use

The choice of diameters is possible over the range [1, 20000] mm.

The number of slots is possible over the range [3, 2400].

The number of poles is possible over the range [2, 400].

For more information, see the list of allowed combinations between the number of slots and the number of poles, synthesized in the section dedicated to winding.

Note: Our processes for building and computations have been qualified over the following data ranges:

Range for diameters [1, 1000] mm.

Range for number of slots [3, 90].

Range for number of poles [2, 80].

Working beyond these limits is possible but accurate results are the responsibility of the user.

## 2.3 Shaft

### 2.3.1 Overview

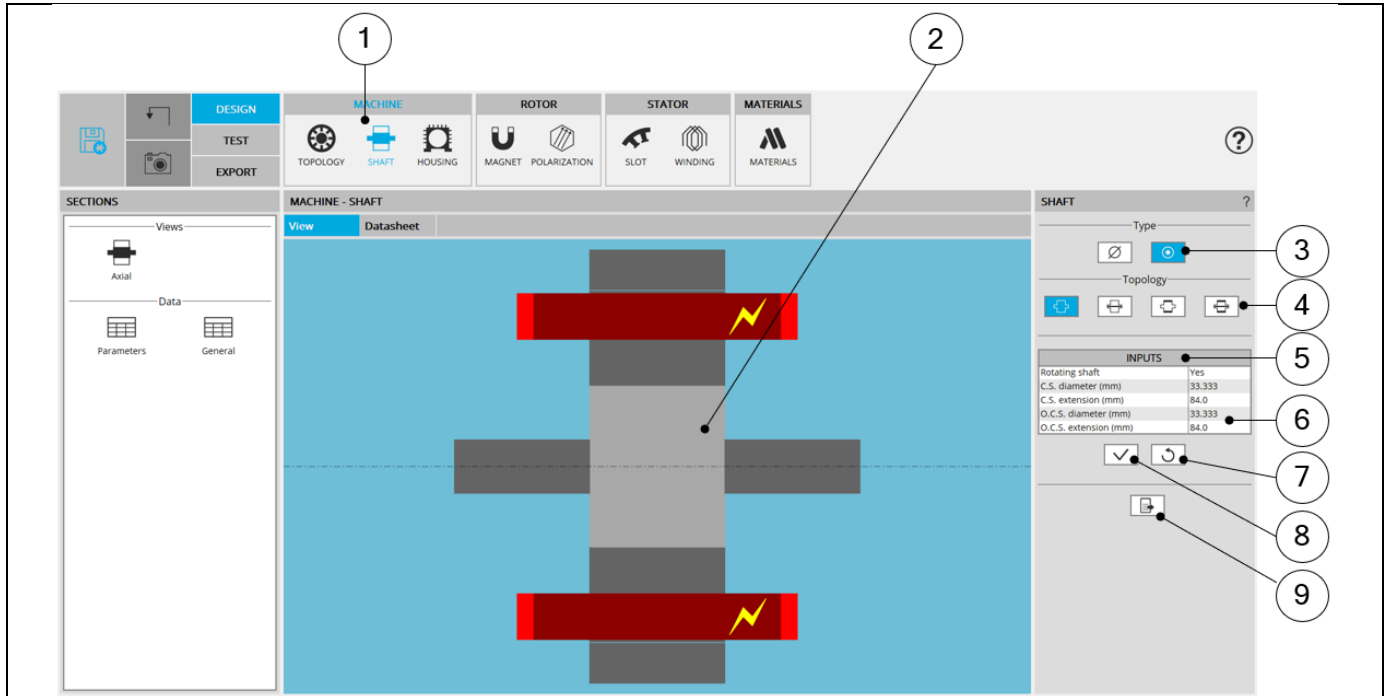

SHAFT design area

1	Selection of the MACHINE subset: SHAFT panel (Click on the icon SHAFT)
2	Visualization of the motor axial view to visualize the shaft topology and dimensions.
3	Choice of the shaft type. Two types are available: <ul style="list-style-type: none"> <li>• None: No dimension to declare. Shaft is replaced by fluid material.</li> <li>• Solid: End-shaft must be defined.</li> </ul> If shaft type is solid, Topology and dimensions of end-shaft must be defined. Note 1: Connection side (C.S.) is identified by yellow lightning. Note 2: Range of definition for dimensions: [0, 20000] mm.
4	Topology of the shaft must be defined: Solid, Solid with hollow, Solid with ring, Solid with hollow and ring
5	Shaft input data to be defined
6	If shaft type is solid, end-shaft must be defined. First indicate if the shaft is rotating or not Note 1: Connection side (C.S.) is identified by yellow lightning. Note 2: Range of definition for dimensions: [0, 20000] mm.
7	Button to restore default input values.
8	Button to Apply inputs. Pressing the enter key twice applies inputs too.
9	Icon to export shaft data into *.txt or *.xlsx files.

### 2.3.2 Shaft type

It is possible to consider a shaft or not:

- Type = None: No shaft represented in the rotor design. It is replaced by a fluid (like air).
- Type = Solid: 4 different topologies of shaft can be considered in the rotor design. It is built with a solid material or laminations. The four topologies are described below.

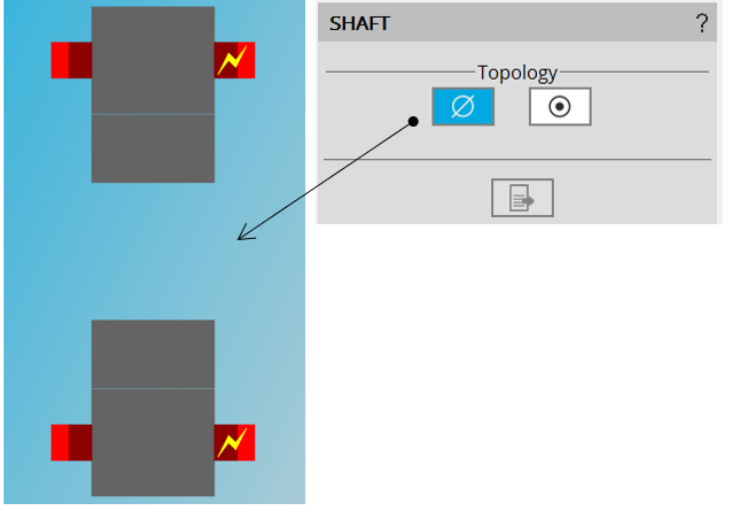

Shaft type: None

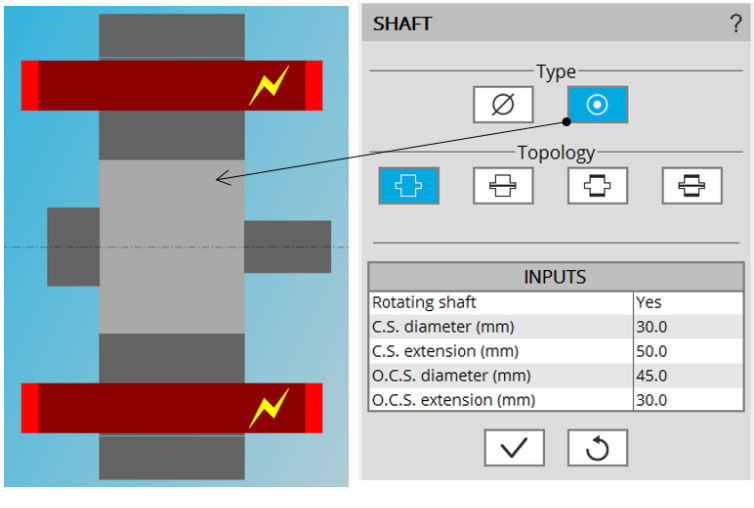

Shaft type: Solid

INPUTS	
Rotating shaft	Yes
C.S. diameter (mm)	30.0
C.S. extension (mm)	50.0
O.C.S. diameter (mm)	45.0
O.C.S. extension (mm)	30.0

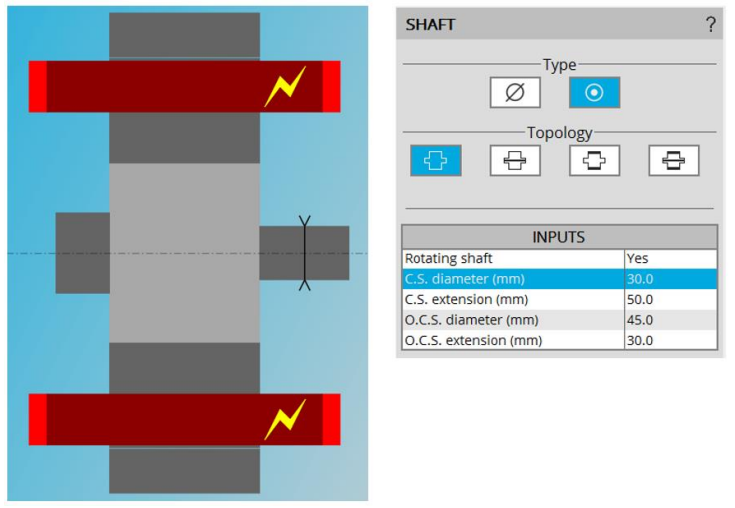

Dimensions are illustrated with arrows

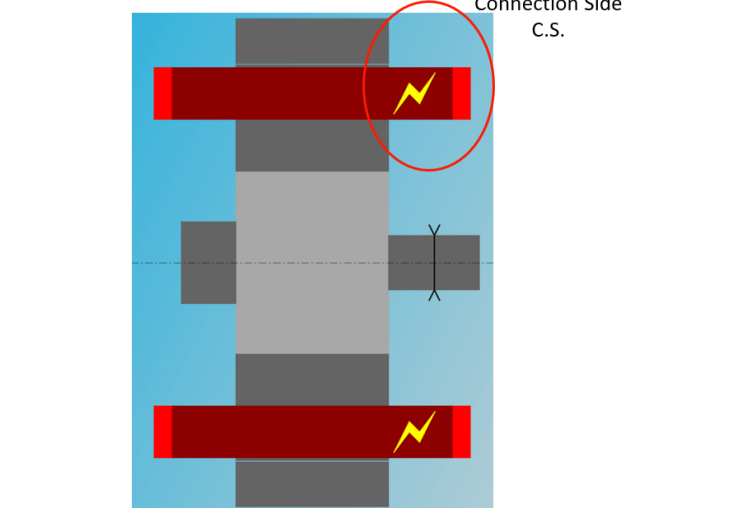

Connection Side (C.S.) is identified by yellow lightning.



### 2.3.3 Shaft topology

Four different topologies of shaft can be considered in the rotor design. They are illustrated below.

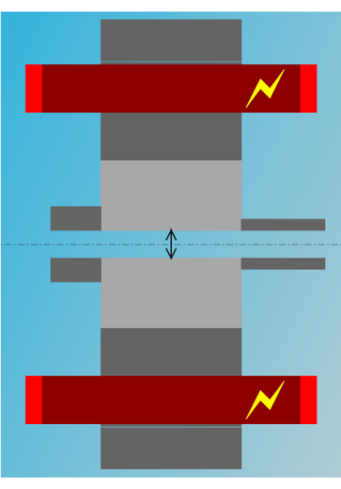
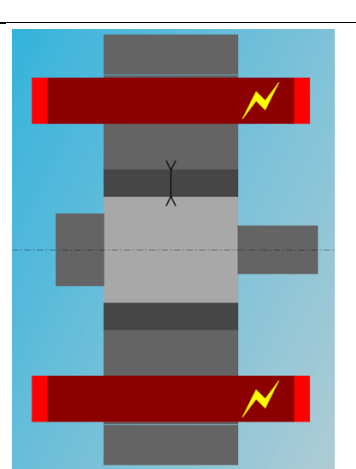
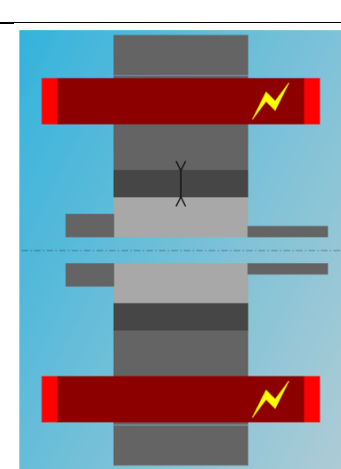
 <p>SHAFT ?</p> <p>Type: <input type="radio"/> <input checked="" type="radio"/></p> <p>Topology: <input checked="" type="checkbox"/> <input type="checkbox"/> <input type="checkbox"/> <input type="checkbox"/></p> <table border="1"> <thead> <tr> <th colspan="2">INPUTS</th> </tr> </thead> <tbody> <tr> <td>Rotating shaft</td> <td>Yes</td> </tr> <tr> <td>C.S. diameter (mm)</td> <td>30.0</td> </tr> <tr> <td>C.S. extension (mm)</td> <td>50.0</td> </tr> <tr> <td>O.C.S. diameter (mm)</td> <td>45.0</td> </tr> <tr> <td>O.C.S. extension (mm)</td> <td>30.0</td> </tr> </tbody> </table>	INPUTS		Rotating shaft	Yes	C.S. diameter (mm)	30.0	C.S. extension (mm)	50.0	O.C.S. diameter (mm)	45.0	O.C.S. extension (mm)	30.0	 <p>SHAFT ?</p> <p>Type: <input type="radio"/> <input checked="" type="radio"/></p> <p>Topology: <input type="checkbox"/> <input checked="" type="checkbox"/> <input type="checkbox"/> <input type="checkbox"/></p> <table border="1"> <thead> <tr> <th colspan="2">INPUTS</th> </tr> </thead> <tbody> <tr> <td>Rotating shaft</td> <td>Yes</td> </tr> <tr> <td>C.S. diameter (mm)</td> <td>30.0</td> </tr> <tr> <td>C.S. extension (mm)</td> <td>50.0</td> </tr> <tr> <td>O.C.S. diameter (mm)</td> <td>45.0</td> </tr> <tr> <td>O.C.S. extension (mm)</td> <td>30.0</td> </tr> <tr> <td>Hollow shaft diameter (mm)</td> <td>16.667</td> </tr> </tbody> </table>	INPUTS		Rotating shaft	Yes	C.S. diameter (mm)	30.0	C.S. extension (mm)	50.0	O.C.S. diameter (mm)	45.0	O.C.S. extension (mm)	30.0	Hollow shaft diameter (mm)	16.667				
INPUTS																															
Rotating shaft	Yes																														
C.S. diameter (mm)	30.0																														
C.S. extension (mm)	50.0																														
O.C.S. diameter (mm)	45.0																														
O.C.S. extension (mm)	30.0																														
INPUTS																															
Rotating shaft	Yes																														
C.S. diameter (mm)	30.0																														
C.S. extension (mm)	50.0																														
O.C.S. diameter (mm)	45.0																														
O.C.S. extension (mm)	30.0																														
Hollow shaft diameter (mm)	16.667																														
<p>Shaft topology 1: Solid</p>	<p>Shaft topology 2: Solid with hollow</p>																														
 <p>SHAFT ?</p> <p>Type: <input type="radio"/> <input checked="" type="radio"/></p> <p>Topology: <input type="checkbox"/> <input type="checkbox"/> <input checked="" type="checkbox"/> <input type="checkbox"/></p> <table border="1"> <thead> <tr> <th colspan="2">INPUTS</th> </tr> </thead> <tbody> <tr> <td>Rotating shaft</td> <td>Yes</td> </tr> <tr> <td>C.S. diameter (mm)</td> <td>30.0</td> </tr> <tr> <td>C.S. extension (mm)</td> <td>50.0</td> </tr> <tr> <td>O.C.S. diameter (mm)</td> <td>45.0</td> </tr> <tr> <td>O.C.S. extension (mm)</td> <td>30.0</td> </tr> <tr> <td>Ring thickness (mm)</td> <td>16.6666666666</td> </tr> </tbody> </table>	INPUTS		Rotating shaft	Yes	C.S. diameter (mm)	30.0	C.S. extension (mm)	50.0	O.C.S. diameter (mm)	45.0	O.C.S. extension (mm)	30.0	Ring thickness (mm)	16.6666666666	 <p>SHAFT ?</p> <p>Type: <input type="radio"/> <input checked="" type="radio"/></p> <p>Topology: <input type="checkbox"/> <input type="checkbox"/> <input type="checkbox"/> <input checked="" type="checkbox"/></p> <table border="1"> <thead> <tr> <th colspan="2">INPUTS</th> </tr> </thead> <tbody> <tr> <td>Rotating shaft</td> <td>Yes</td> </tr> <tr> <td>C.S. diameter (mm)</td> <td>30.0</td> </tr> <tr> <td>C.S. extension (mm)</td> <td>50.0</td> </tr> <tr> <td>O.C.S. diameter (mm)</td> <td>45.0</td> </tr> <tr> <td>O.C.S. extension (mm)</td> <td>30.0</td> </tr> <tr> <td>Hollow shaft diameter (mm)</td> <td>16.667</td> </tr> <tr> <td>Ring thickness (mm)</td> <td>16.6666666666</td> </tr> </tbody> </table>	INPUTS		Rotating shaft	Yes	C.S. diameter (mm)	30.0	C.S. extension (mm)	50.0	O.C.S. diameter (mm)	45.0	O.C.S. extension (mm)	30.0	Hollow shaft diameter (mm)	16.667	Ring thickness (mm)	16.6666666666
INPUTS																															
Rotating shaft	Yes																														
C.S. diameter (mm)	30.0																														
C.S. extension (mm)	50.0																														
O.C.S. diameter (mm)	45.0																														
O.C.S. extension (mm)	30.0																														
Ring thickness (mm)	16.6666666666																														
INPUTS																															
Rotating shaft	Yes																														
C.S. diameter (mm)	30.0																														
C.S. extension (mm)	50.0																														
O.C.S. diameter (mm)	45.0																														
O.C.S. extension (mm)	30.0																														
Hollow shaft diameter (mm)	16.667																														
Ring thickness (mm)	16.6666666666																														
<p>Shaft topology 3: Solid with ring</p>	<p>Shaft topology 4: Solid with hollow and ring</p>																														

## 2.3.4 Inputs

Solid shaft inputs:

Label	Symbol	Tooltip, note, formula
Rotating shaft	ROT	Yes / No
C.S. diameter	D1	Connection side end-shaft diameter.
C.S. extension	L1	Connection side end-shaft extension.
O.C.S. diameter	D2	Opposite connection side end-shaft diameter.
O.C.S. extension	L2	Opposite connection side end-shaft extension.

Solid shaft with hollow inputs:

Label	Symbol	Tooltip, note, formula
Rotating shaft	ROT	Yes / No
C.S. diameter	D1	Connection side end-shaft diameter.
C.S. extension	L1	Connection side end-shaft extension.
O.C.S. diameter	D2	Opposite connection side end-shaft diameter.
O.C.S. extension	L2	Opposite connection side end-shaft extension.
Hollow shaft diameter	D0	Inner diameter of hollow shaft

Solid shaft with ring inputs:

Label	Symbol	Tooltip, note, formula
Rotating shaft	ROT	Yes / No
C.S. diameter	D1	Connection side end-shaft diameter.
C.S. extension	L1	Connection side end-shaft extension.
O.C.S. diameter	D2	Opposite connection side end-shaft diameter.
O.C.S. extension	L2	Opposite connection side end-shaft extension.
Ring thickness	THR	Ring thickness

Solid shaft with hollow and ring inputs:

Label	Symbol	Tooltip, note, formula
Rotating shaft	ROT	Yes / No
C.S. diameter	D1	Connection side end-shaft diameter.
C.S. extension	L1	Connection side end-shaft extension.
O.C.S. diameter	D2	Opposite connection side end-shaft diameter.
O.C.S. extension	L2	Opposite connection side end-shaft extension.
Hollow shaft diameter	D0	Inner diameter of hollow shaft
Ring thickness	THR	Ring thickness

## 2.3.5 Display Fix and rotating parts

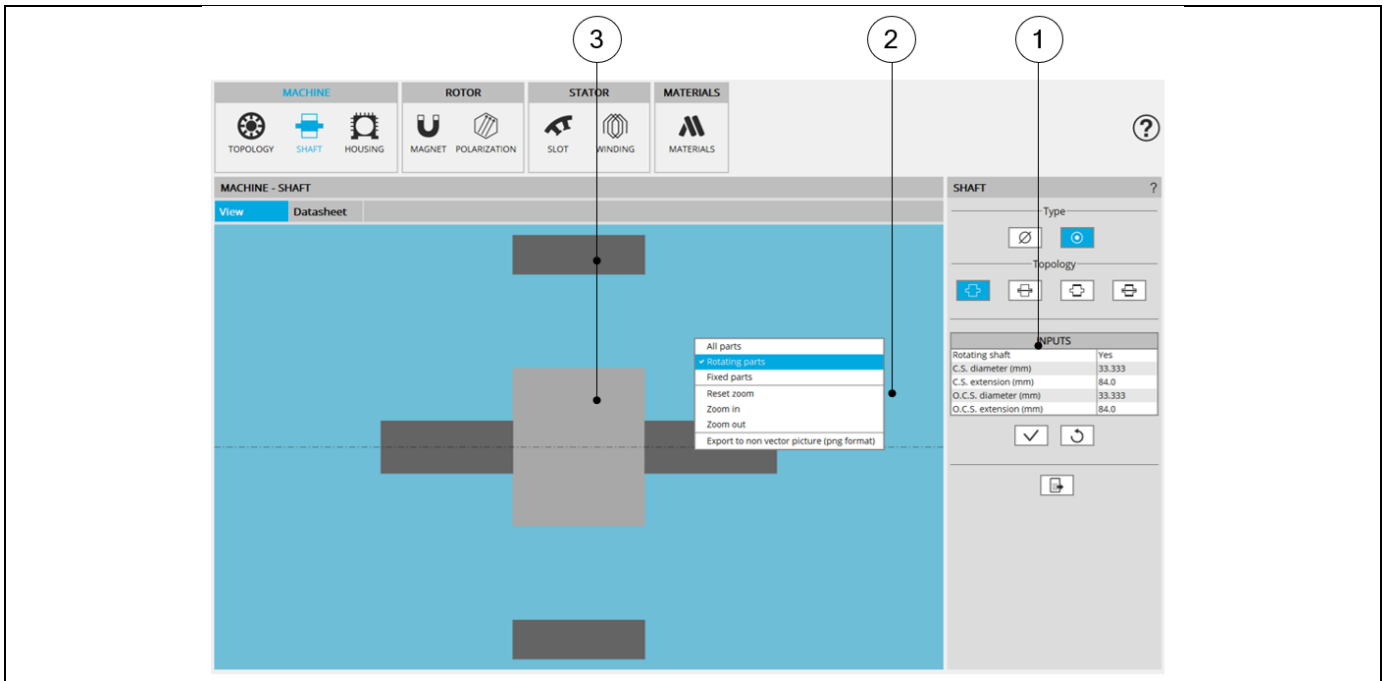

SHAFT design area – Displaying of parts of the motor

1	The shaft is rotating or not
2	A right click of the mouse opens a dialog box allowing to display all parts or either Rotating parts or Fixed parts
3	The parts are displayed considering the previous choice

## 2.4 Housing

### 2.4.1 Overview

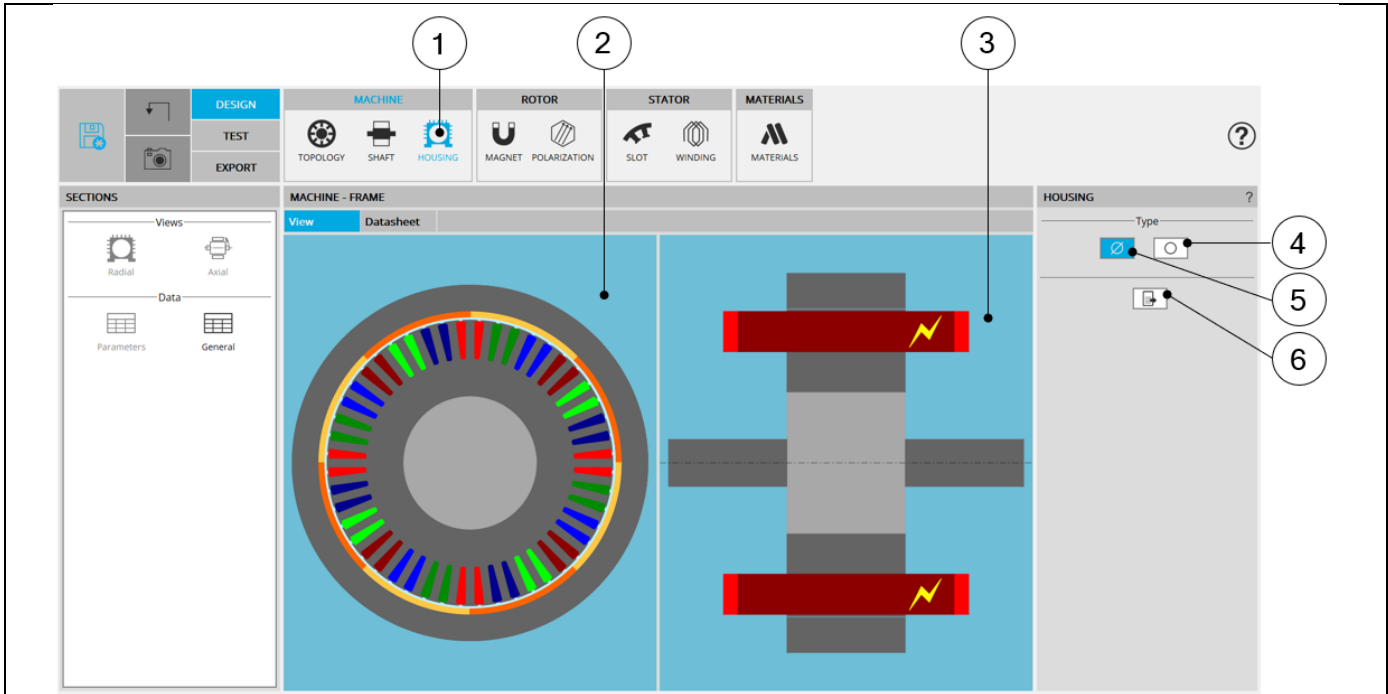

HOUSING design area

1	Selection of the MACHINE subset: HOUSING panel (Click on the icon HOUSING)
2	Radial view of the motor
3	Axial view of the motor
4	Selected button to set a circular shape frame.
5	Default setting : Housing type is « None » The machine has no frame.
6	Icon to export frame data into *.txt or *.xlsx files.

2.4.2 Frame design area

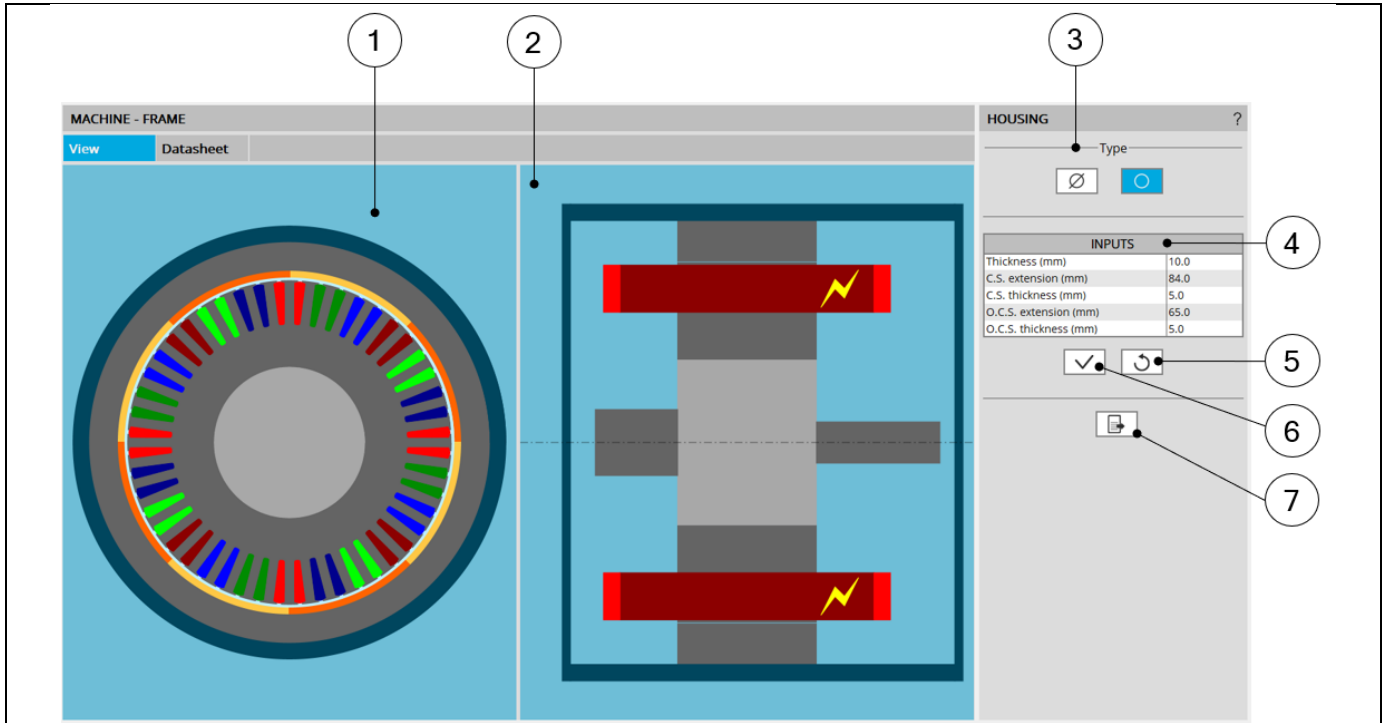

Circular shape frame design area

1	Radial view of the motor, including the housing topology and dimensions.
2	Axial view of the motor, including the housing topology and dimensions.
3	Selected button to consider a frame or not.
4	User input parameters to define the frame dimensions. For more information see below.
5	Button to restore default input values.
6	Button to apply inputs. Pressing the enter key twice applies inputs too.
7	Icon to export frame data into *.txt or *.xlsx files.

	1	Thickness of the frame. Allowed range of values ]0, 50] mm.
	2	Connection side (C.S.) is identified by yellow lightning.
	3	Connection side extension. Allowed range of values [0, 20000] mm.
	4	Connection side – End-plate thickness. Allowed range of values ]0, 50] mm.
	5	Opposite connection side extension. Allowed range of values [0, 20000] mm.
	6	Opposite connection side – End-plate thickness. Allowed range of values ]0, 50] mm.

User input parameters to define frame dimensions in the axial view

## 2.5 Magnet

### 2.5.1 Overview

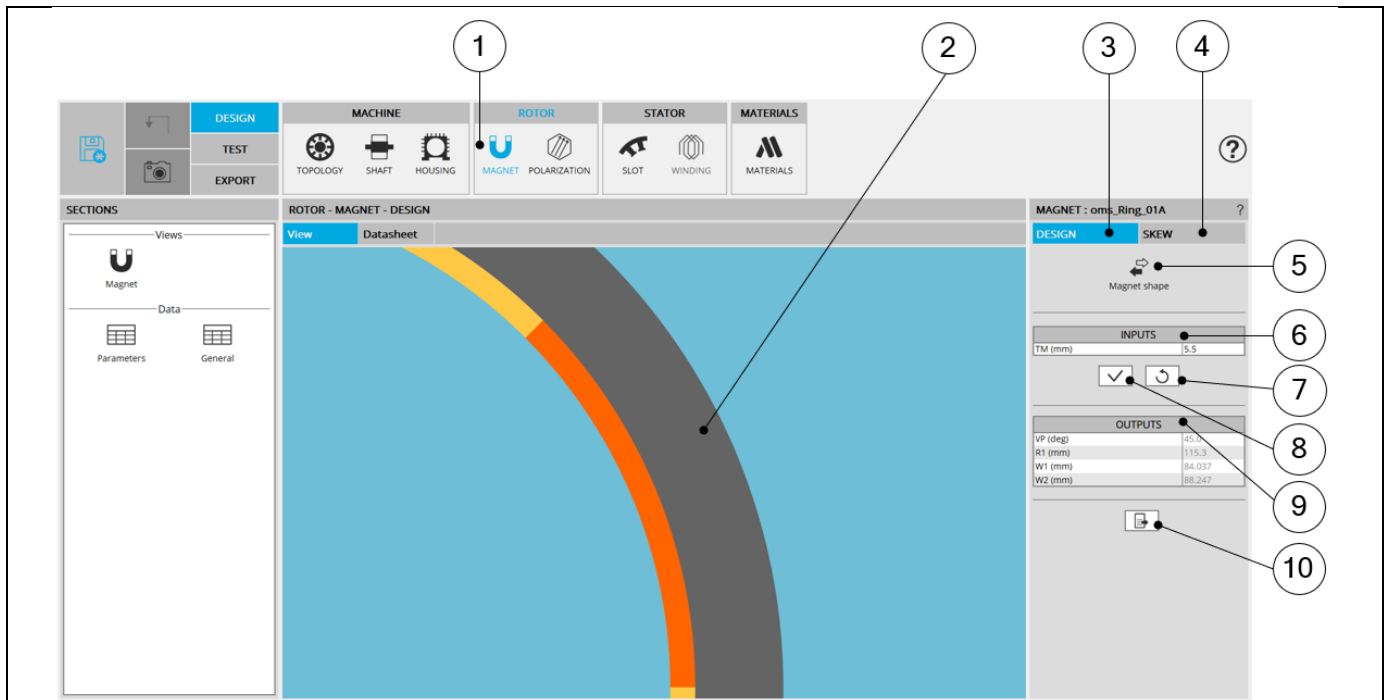

MAGNET design area

1	Selection of the ROTOR subset: MAGNET panel (Click on the icon MAGNET)
2	Visualization of the motor radial view to view the magnet topology and dimensions.
3	DESIGN tab indicates the tools to define the magnet topology and parameter values Note: By default, DESIGN tab is selected
4	SKEW tab indicates the tools to define the rotor (magnet) skewing angle
5	"Magnet shape" button allows accessing the magnet libraries to change the magnet topology. See additional information below.
6	User input parameter fields to enter the values.
7	Button to restore default input values.
8	Button to apply inputs. Pressing the "enter key" twice applies inputs too.
9	Output parameters (read only data) complete the description of the topology.
10	Icon to export magnet data into *.txt or *.xlsx files.

## 2.5.2 Magnet - Design

### 2.5.2.1 Choose a magnet topology

Clicking on the "Magnet shape" button opens a dialog box, allowing to access to the magnet libraries. It allows visualizing, comparing, choosing, and importing another magnet topology to modify in the current rotor design.

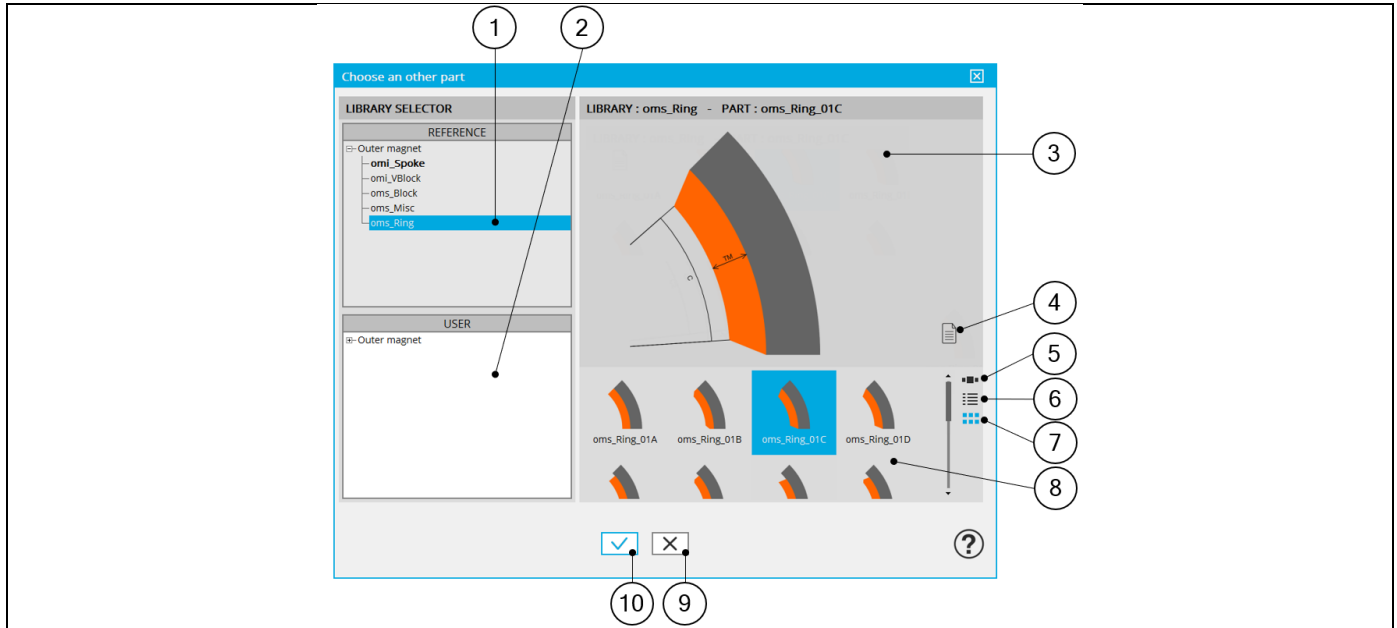

How to choose another magnet topology?

1	Visualization of reference libraries i.e. the libraries of magnet's topologies provided with FluxMotor®. Select them to view their content and choose the magnet among their content. See "Part Library" application for more information.
2	Visualization of user libraries. The default user library is "UserInnerMagnet". See "Part Library" application for more information.
3	Area where the selected magnet is displayed (static picture) – Topology + dimension labels.
4	Button to visualize the list of documents attached to the part. See additional information below.
5	Button to display thumbnails as a slide show.
6	Button to display thumbnails as a list.
7	Button to display thumbnails as a matrix view of pictures.
8	Area to visualize all the topologies of magnets from the selected library (ref. 1).
9	Button to close the dialog box and come back to Motor Factory – DESIGN – Magnet area.
10	Button to choose and import the selected magnet to modify the current rotor design.

### 2.5.2.2 Attached documents – Additional information

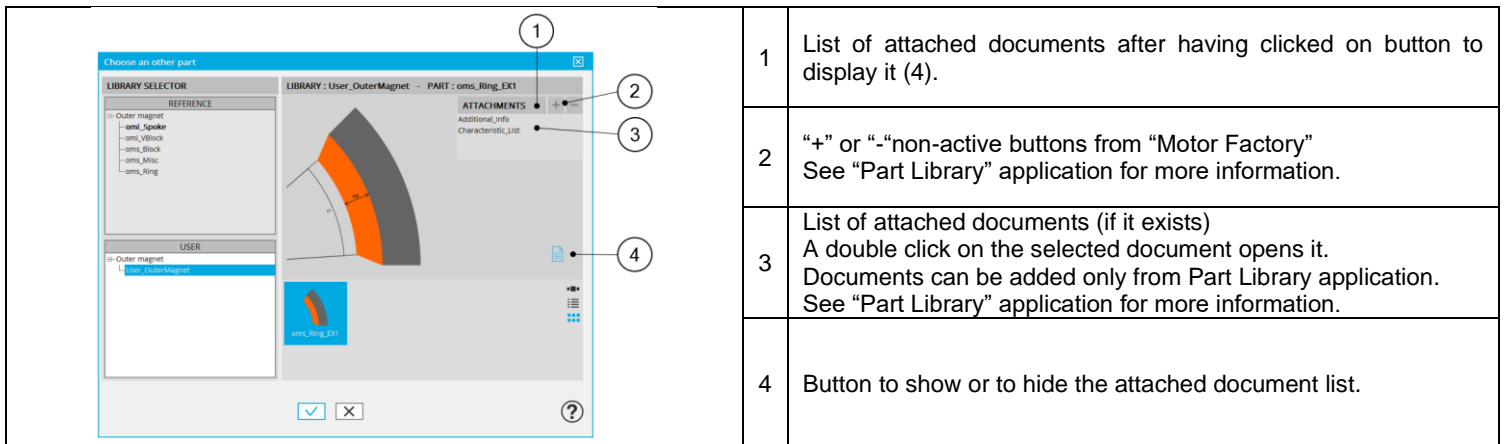

1	List of attached documents after having clicked on button to display it (4).
2	"+" or "-" non-active buttons from "Motor Factory" See "Part Library" application for more information.
3	List of attached documents (if it exists) A double click on the selected document opens it. Documents can be added only from Part Library application. See "Part Library" application for more information.
4	Button to show or to hide the attached document list.

Visualization of attached documents

### 2.5.2.3 Inputs / Outputs

Specific inputs and outputs are considered for magnet topology.

The relevance of input parameter values can be evaluated by using “Part Factory” application. See “Part Factory” application for more information.

Outputs are read only data. They complete the description of the topology.

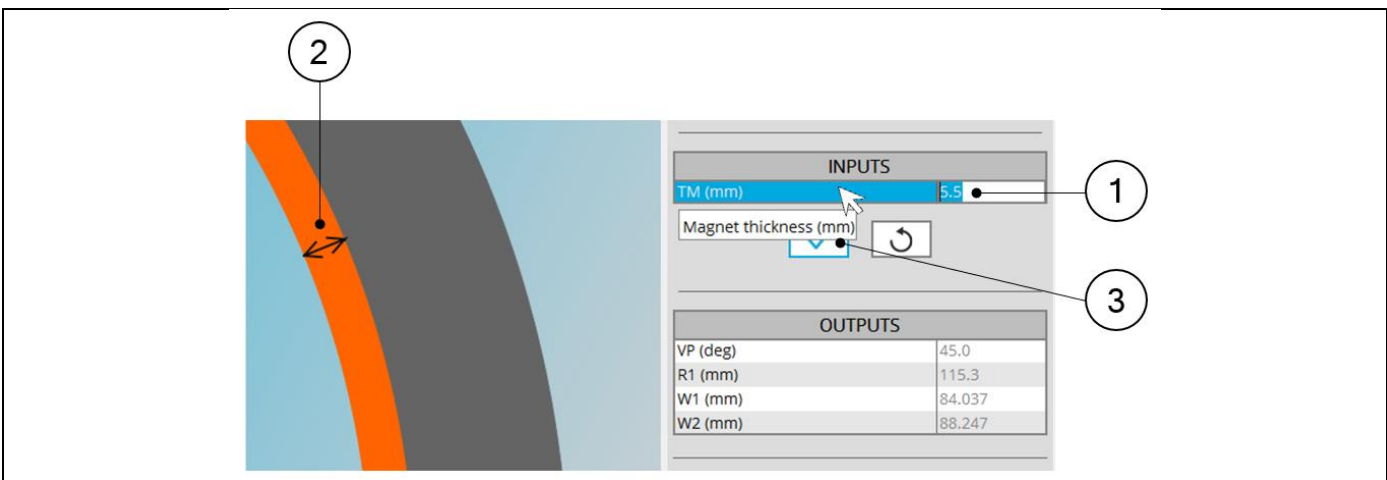
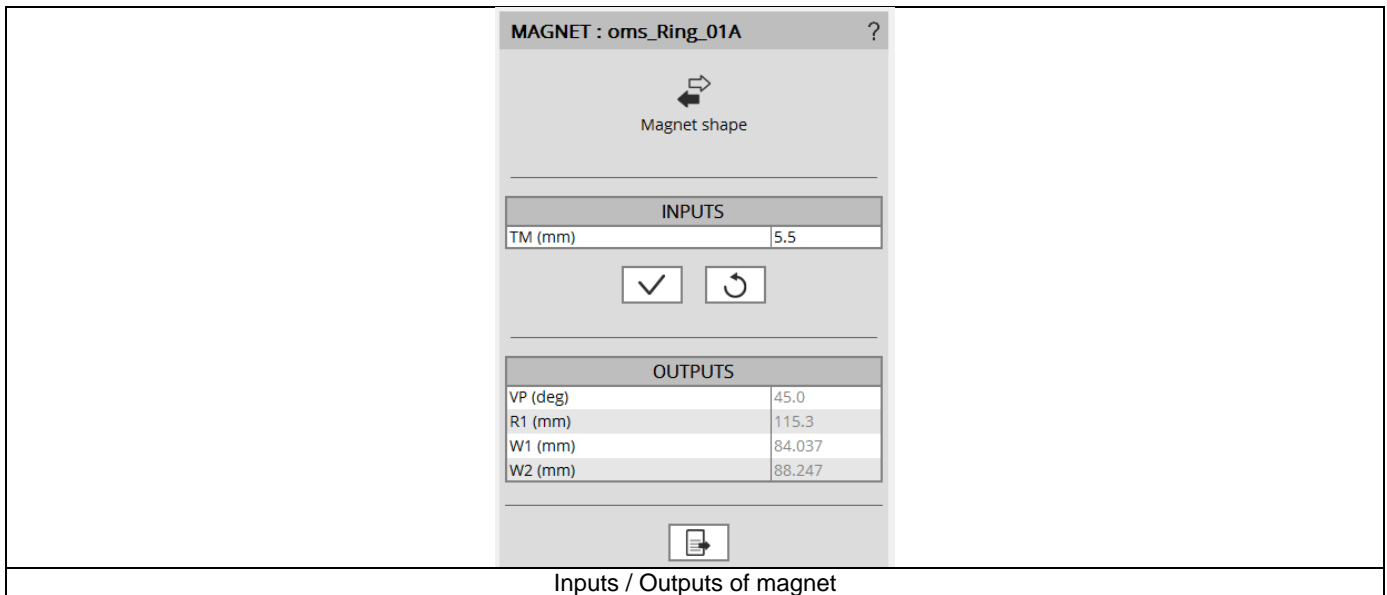

1	Selection of a parameter label highlights it.
2	Selection of a parameter label displays the corresponding arrow on the picture.
3	Selection of a parameter label displays the corresponding tooltip which completes information about the parameter.



## 2.5.3 Magnet – Skew

## 2.5.3.1 Overview

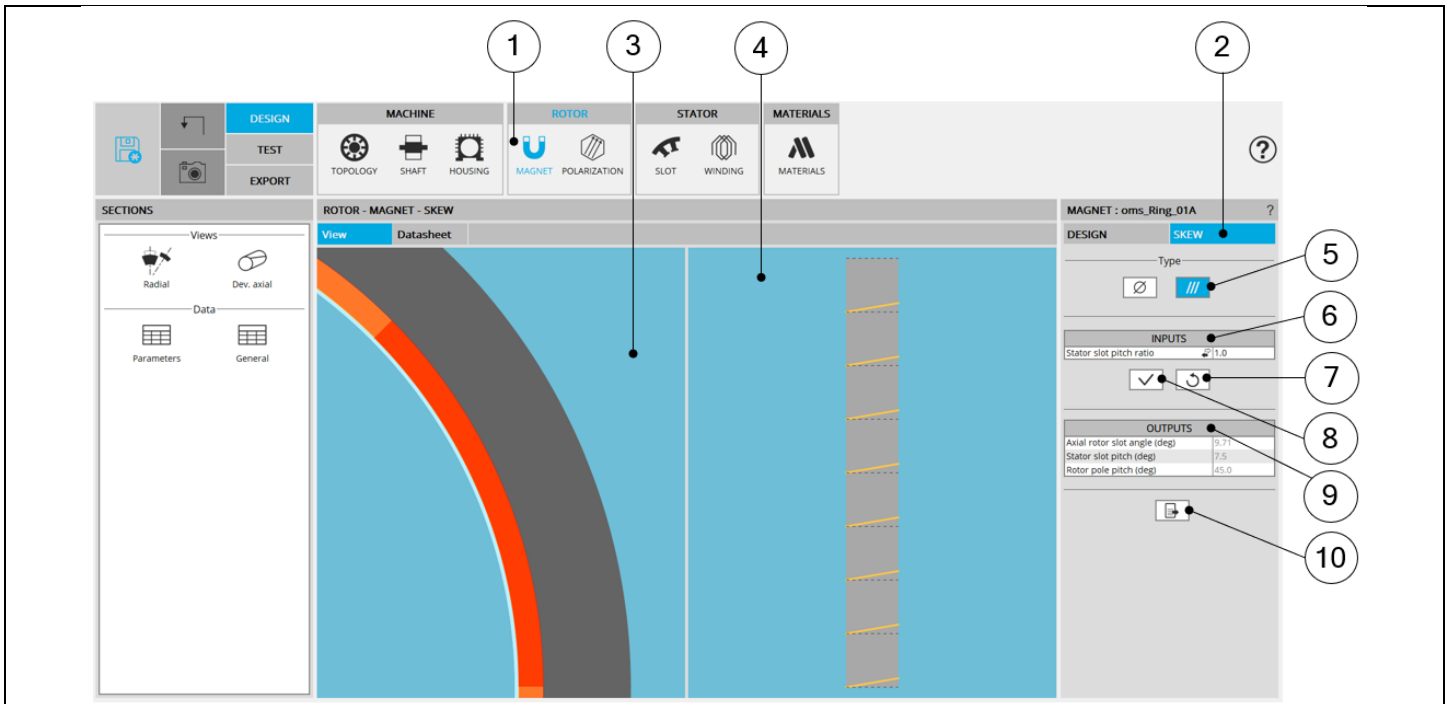

MAGNET – SKEW design area

1	Selection of the ROTOR subset: MAGNET panel (Click on the icon MAGNET)
2	SKEW tab indicates the tools to define the rotor (magnet) skewing angle
3	Visualization of the motor radial view with magnet topology and dimensions.
4	Visualization of the rotor developed view to visualize the rotor (magnet) skewing
5	Choices to define a skew: None – Continuous (Continuous in our example)
6	Skew inputs to be defined
7	Buttons to restore the default input values (Pressing the “enter key” twice applies inputs too).
8	Buttons to validate the inputs (Pressing the “enter key” twice applies inputs too).
9	Skew outputs (read only)
10	Button to export the skew data into *.txt or *.xlsx files.

## 2.5.3.2 Set a skew angle

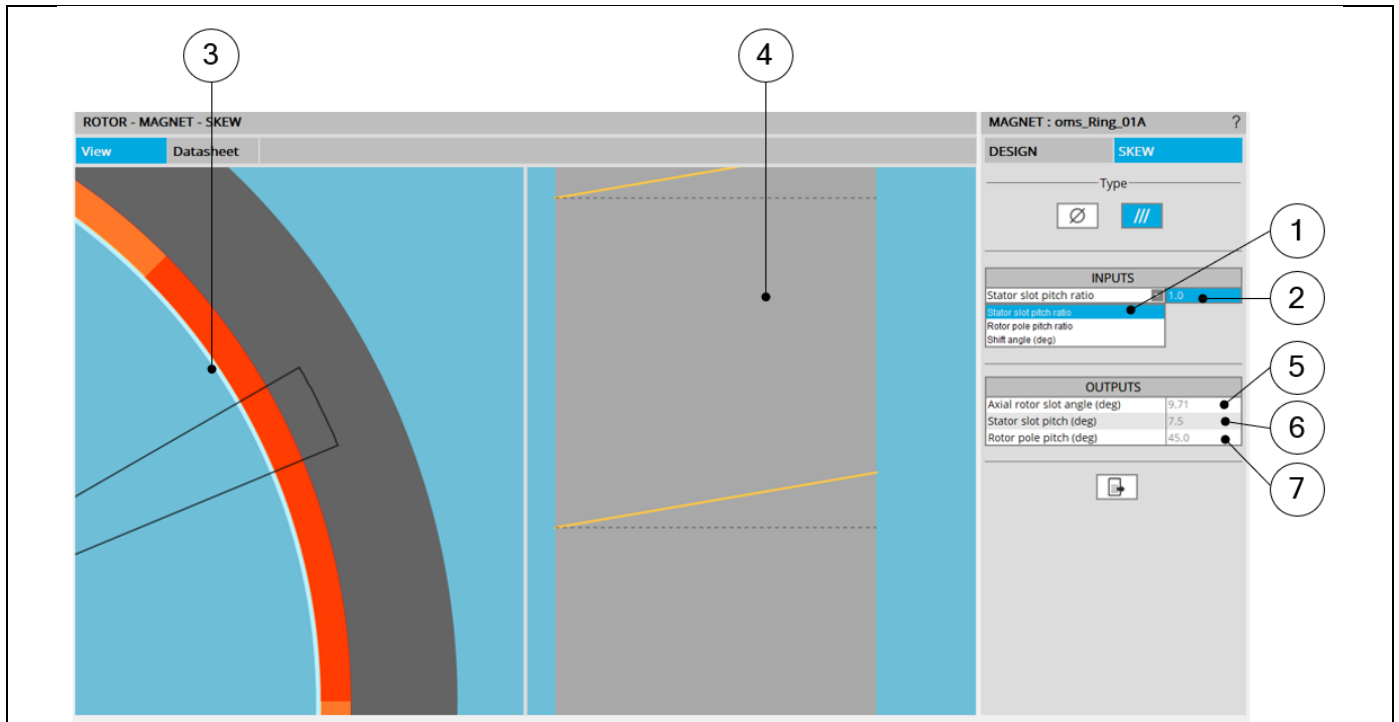

## How to set a skew angle?

1	Choose the definition mode of the skew: Stator slot – Rotor slot – Shift angle
2	Definition of the skew angle depending on the definition mode
3	Visualization of the chosen skew angle on the machine radial view
4	Visualization of the equivalent axial slot angle on the rotor developed view
5	Equivalent axial rotor slot angle (read only)
6	Equivalent stator slot pitch (read only)
7	Equivalent rotor slot pitch (read only)

Note: The user can add a skew angle on the rotor or on the stator. If a skew is already defined in the stator when setting a skew on the rotor, the stator skewing will be automatically reset to “None”.

## 2.6 Polarization

### 2.6.1 Overview

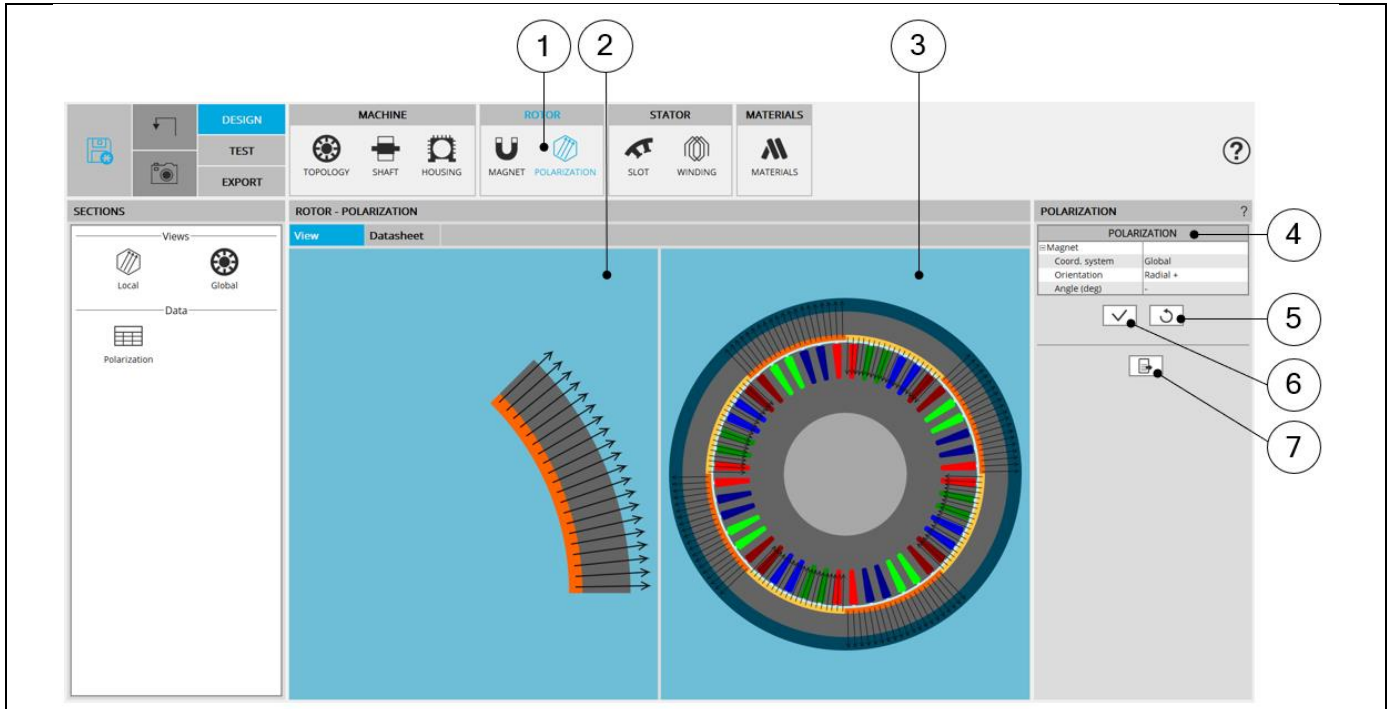

POLARIZATION design area

1	Selection of the ROTOR subset: POLARIZATION panel (Click on the icon POLARIZATION)
2	Visualization of the polarization on one pole.
3	Visualization of the polarization on the whole machine.
4	Area to choose the polarization strategy. Five types of orientation and two coordinate systems and angle are available. See additional information below.
5	Button to restore default input values. Default polarization is defined in Part Factory application via Excel file. See "Part Factory" application for more information.
6	Button to Apply inputs. Pressing the enter key twice applies inputs too.
7	Icon to export polarization data into *.txt or *.xlsx files.

### 2.6.2 Choice of polarization

#### 2.6.2.1 Polarization coordinate system

Two coordinate systems are available:

A **"Global"** polarization coordinate system: The origin is positioned at the rotor center.

A **"Local"** polarization coordinate system which is specific to each considered magnet topology.

Note: The reference axis (X-axis for Cartesian coordinate system) has a red color.

#### 2.6.2.2 Polarization orientation

Five strategies of polarization are proposed:

- Direction
- Radial +, Radial –
- Orthoradial +, Orthoradial –

2.6.2.3 Polarization orientation illustrations

1	Global coordinate system. The origin is positioned at the rotor center. The reference axis is the X-axis. Its color is red.
2	Local coordinate system. Its location is defined for each magnet topology. See "Part Factory" application for more information. The reference axis is the X-axis. Its color is red.
3	Borders of part sector in which magnet topology is defined.
4	Magnet in which a point P is considered to illustrate the polarization orientation.
5	Polarization of the magnet considered at any point P.

Legend of pictures to illustrate the magnet polarization orientation

<p>Polarization / <b>Radial +</b> Global coordinate system</p>	<p>Polarization / <b>Radial -</b> Global coordinate system</p>
--	--

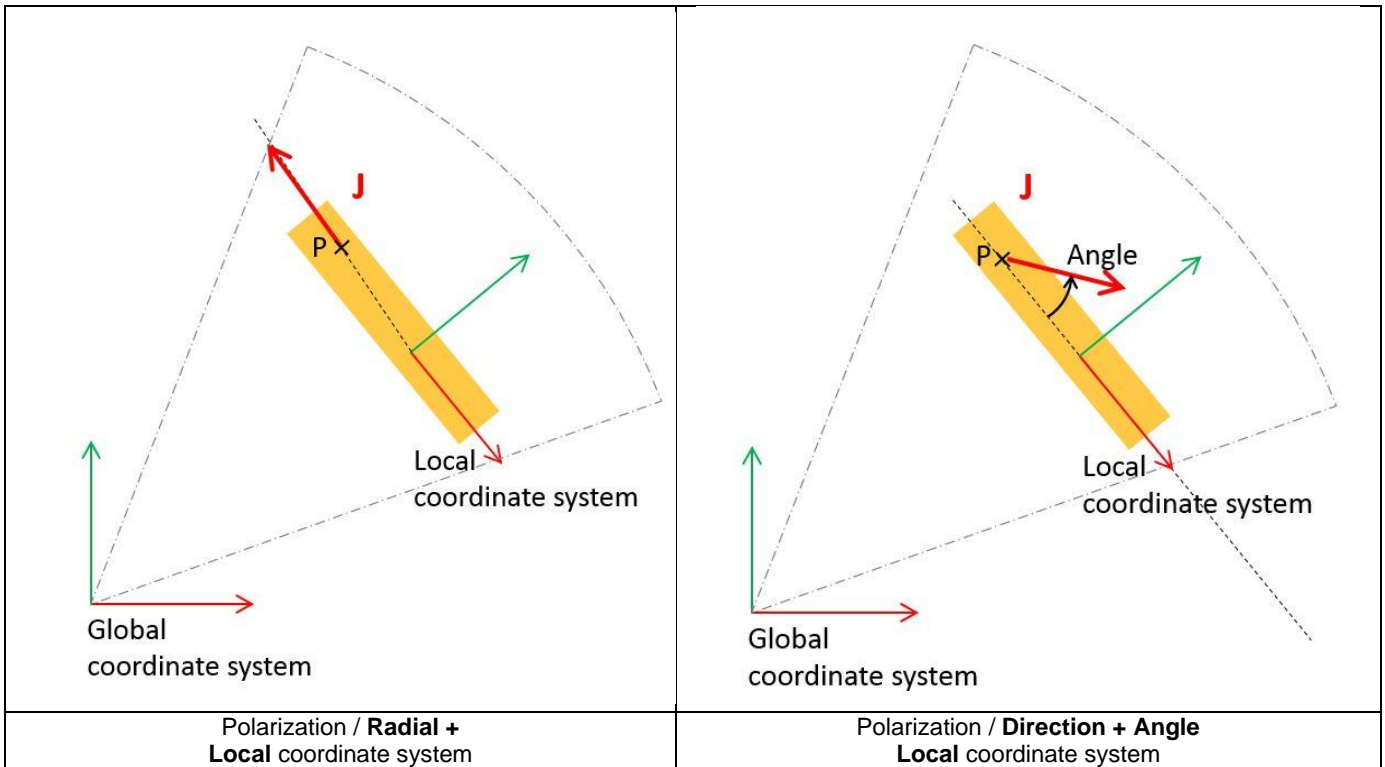
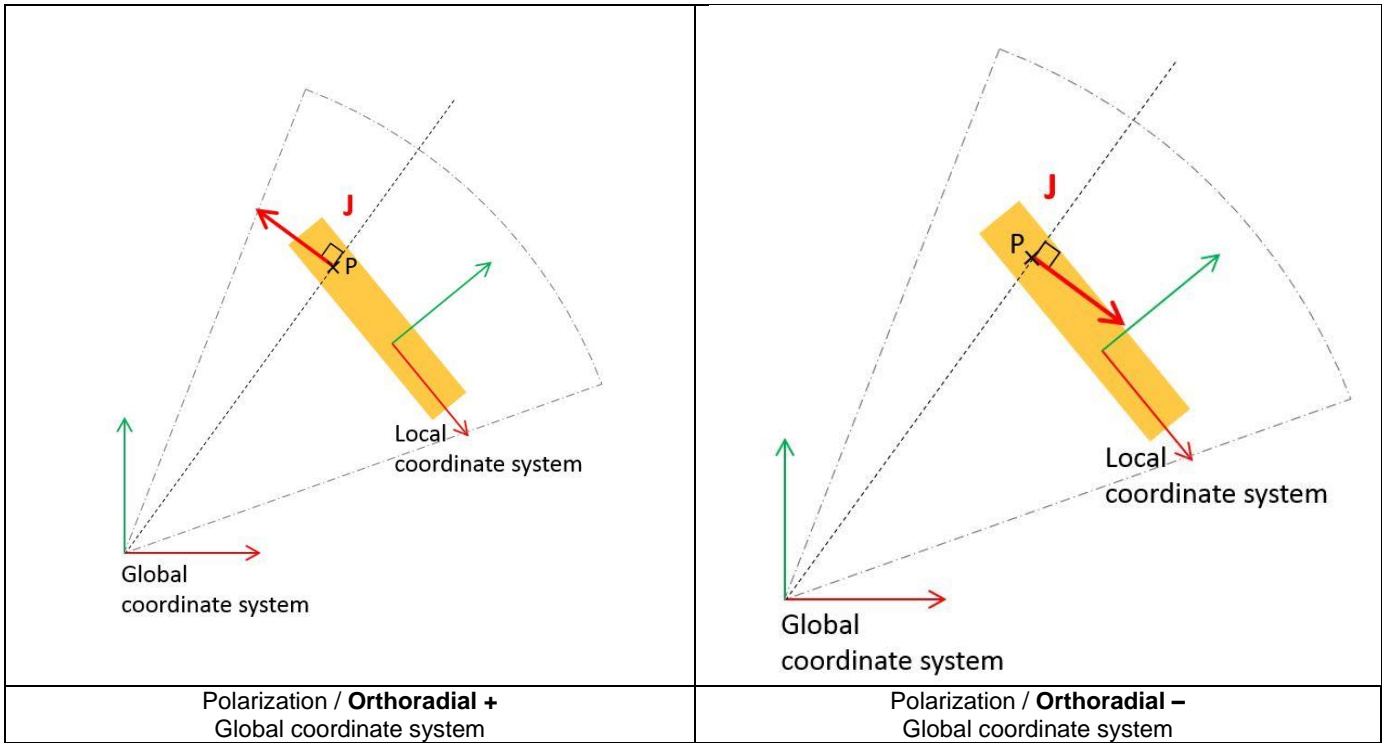

## 2.7 Slot

### 2.7.1 Overview

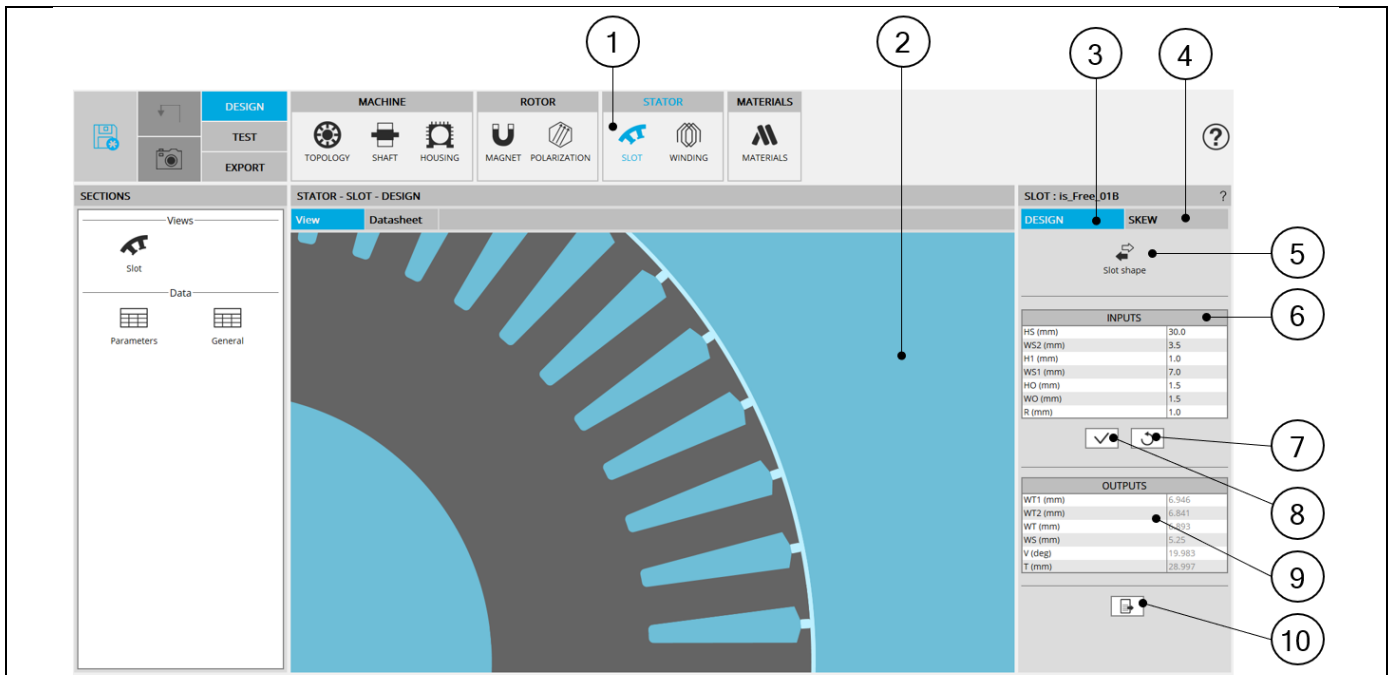

#### SLOT design area

1	Selection of the STATOR subset: SLOT panel (Click on the icon SLOT)
2	Visualization of the motor radial view to see the slot topology and dimensions.
3	DESIGN tab indicates the tools to define the slot topology and parameter values Note: By default, DESIGN tab is selected
4	SKEW tab indicates the tools to define the slot skewing angle
5	"Slot shape" button allows accessing the slot libraries to change the slot topology. See additional information below.
6	User input parameter fields to enter the value.
7	Button to restore default input values.
8	Button to Apply inputs. Pressing the enter key twice applies inputs too.
9	Output parameters (read only data) to complete the description of the topology.
10	Icon to export slot data into *.txt or *.xlsx files.

## 2.7.2 Slot - Design

### 2.7.2.1 Choose a slot topology

Clicking on the "Slot shape" button opens a dialog box, allowing access to the slot libraries.

It allows visualizing, comparing, choosing, and importing another slot topology to modify the current stator design.

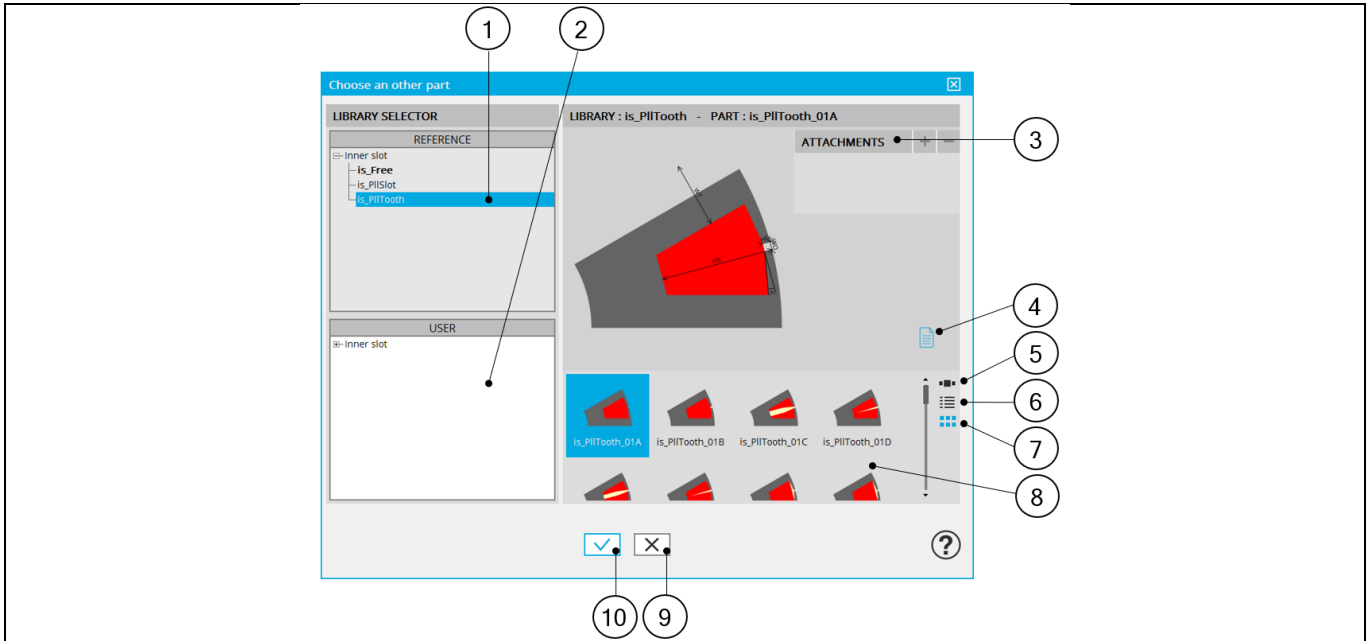

How to choose another slot topology?

1	Visualization of reference libraries i.e. the libraries of slot topologies provided with FluxMotor®. Select them to view their content and choose the slot among them. See “Part Library” application for more information.
2	Visualization of user libraries. The default user library is “UserOuterSlot” See “Part Library” application for more information.
3	Area where the selected slot is displayed (static picture) – Topology + dimension labels.
4	Button to visualize the list of documents attached to the part. See additional information below.
5	Button to display thumbnails as a slide show.
6	Button to display thumbnails as a list.
7	Button to display thumbnails as a matrix view of pictures.
8	Area to visualize all the topologies of slots from the selected library (ref. 1).
9	Button to close the dialog box and come back to Motor Factory – DESIGN – Slot area.
10	Button to choose and import the selected slot to modify the current stator design.

### 2.7.2.2 Attached documents – Additional information

	1	Attached document list after having clicked on button to display it (4).
	2	“+” or “-“ non-active buttons from “Motor Factory”. See “Part Library” application for more information.
	3	List of attached documents (if present). A double click on the selected document opens it. Documents can be added only from Part Library application. See “Part Library” application for more information.
	4	Button to show or hide the attached document list.
Visualization of attached documents		

### 2.7.2.3 Inputs / Outputs

Specific inputs and outputs are considered for each slot topology.

The relevance of input parameters values can be evaluated by using “Part Factory” application. See “Part Factory” application for more information.

Outputs are read only data. They complete the description of the topology.

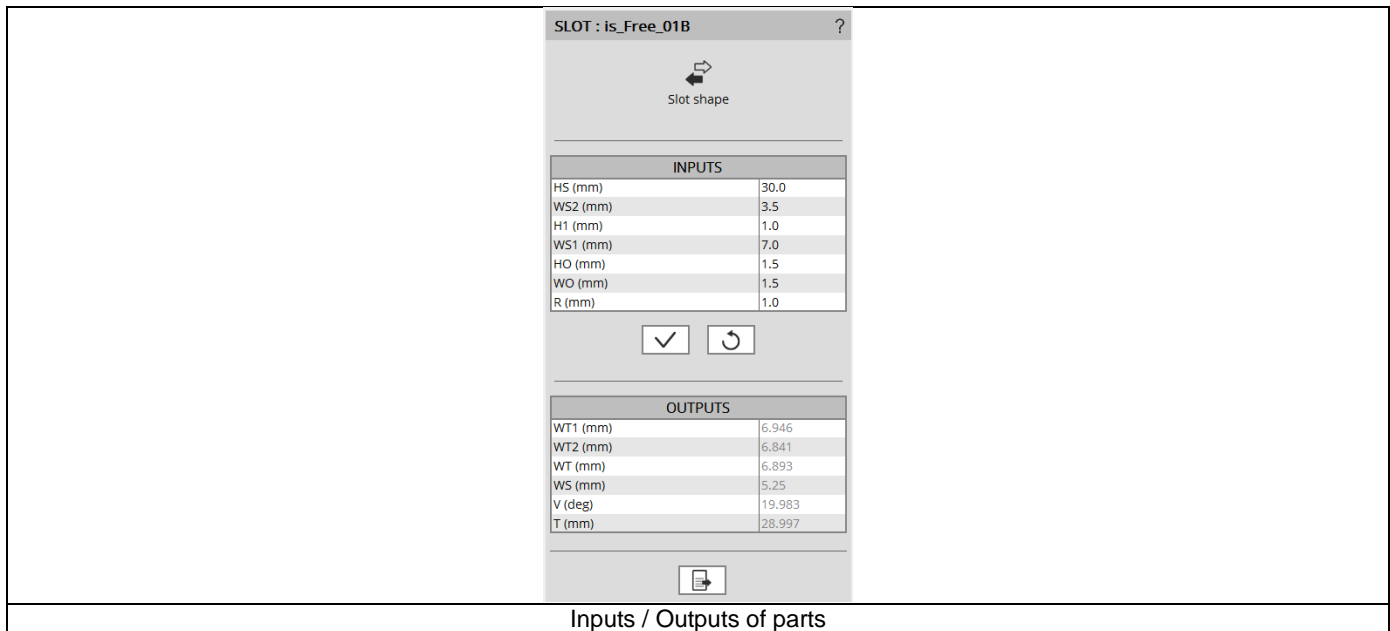

The screenshot shows a configuration window for a slot named 'SLOT : is\_Free\_01B'. It features a 'Slot shape' icon at the top, followed by an 'INPUTS' table and an 'OUTPUTS' table. Below the tables are checkmark and refresh icons, and a print icon at the bottom.

INPUTS	
HS (mm)	30.0
WS2 (mm)	3.5
H1 (mm)	1.0
WS1 (mm)	7.0
HO (mm)	1.5
WO (mm)	1.5
R (mm)	1.0

OUTPUTS	
WT1 (mm)	6.946
WT2 (mm)	6.841
WT (mm)	6.893
WS (mm)	5.25
V (deg)	19.983
T (mm)	28.997

**Inputs / Outputs of parts**

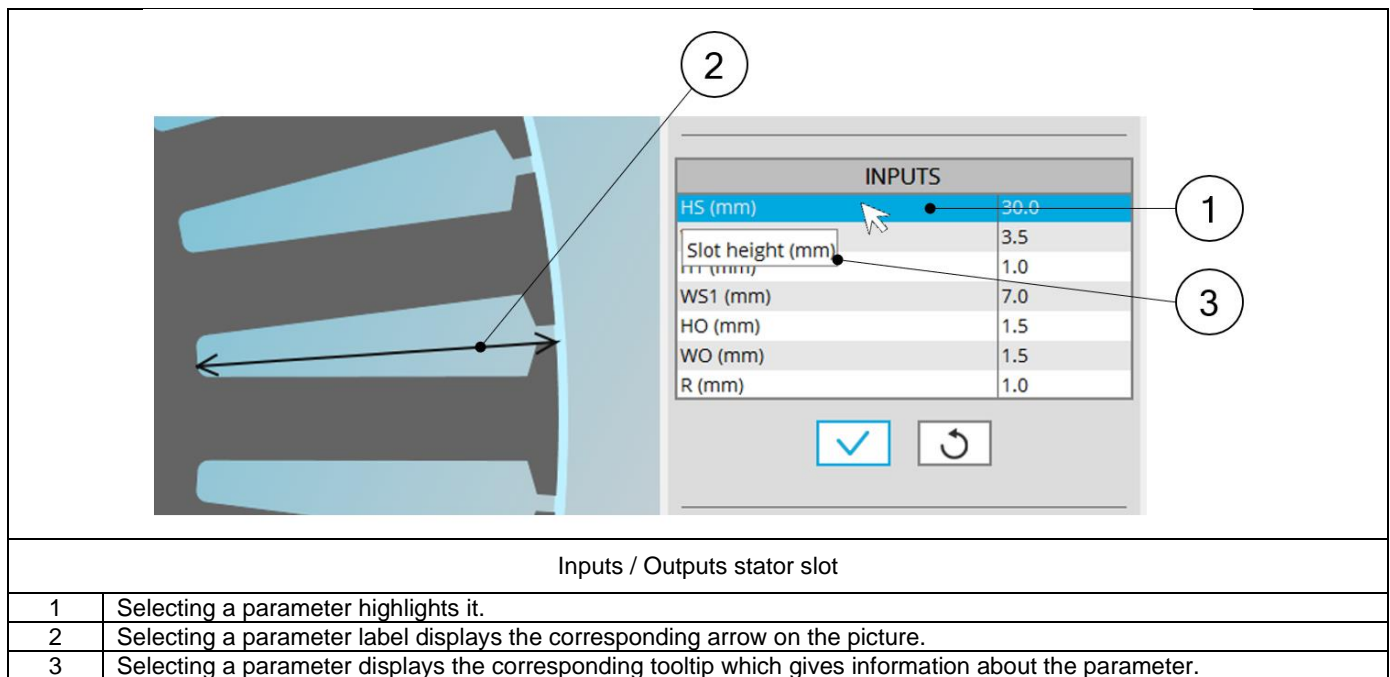

The diagram shows a cross-section of a stator slot with three teeth. A configuration window for 'INPUTS' is overlaid on the right. Callout 1 points to the 'HS (mm)' row, callout 2 points to the 'HS (mm)' label, and callout 3 points to the 'Slot height (mm)' tooltip. The tooltip shows a vertical dimension line across the slot height.

INPUTS	
HS (mm)	30.0
Slot height (mm)	3.5
H1 (mm)	1.0
WS1 (mm)	7.0
HO (mm)	1.5
WO (mm)	1.5
R (mm)	1.0

**Inputs / Outputs stator slot**

1	Selecting a parameter highlights it.
2	Selecting a parameter label displays the corresponding arrow on the picture.
3	Selecting a parameter displays the corresponding tooltip which gives information about the parameter.



## 2.7.3 Slot – Skew

## 2.7.3.1 Overview

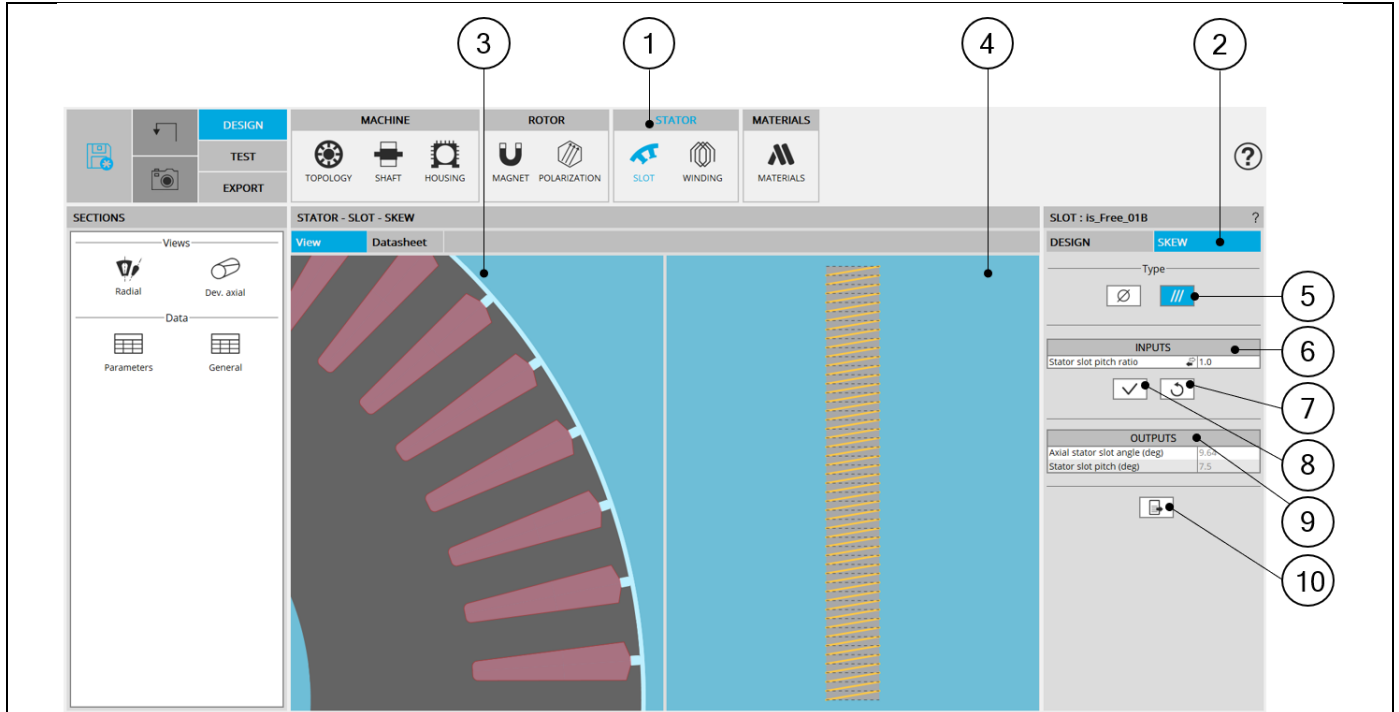

## SLOT – SKEW design area

1	Selection of the STATOR subset: SLOT panel (Click on the icon SLOT)
2	Skew tab indicates the tool to define the slot skew angle
3	Visualization of the machine radial view to visualize the slot skew
4	Visualization of the stator developed view to visualize the slot skew
5	Choices to define a skew: None – Continuous (Continuous in our example)
6	Skew inputs to be defined
7	Buttons to validate the inputs (Pressing the “enter key” twice applies inputs too).
8	Buttons to restore the default input values.
9	Skew outputs (read only)
10	Button to export the skew data into *.txt or *.xlsx files.

## 2.7.3.2 Set a skew angle

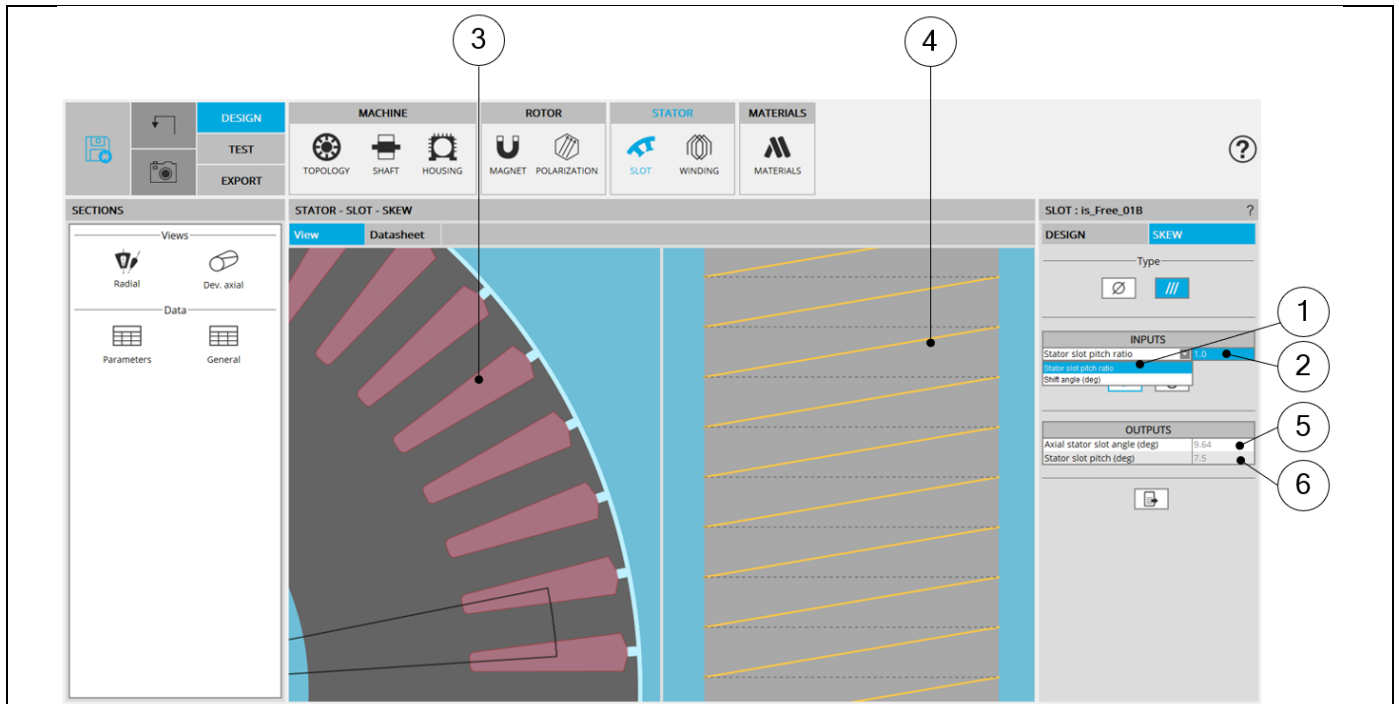

## How to set a skew angle?

1	Choose the definition mode of the skew: Stator slot – Shift angle
2	Definition of the skew angle depending on the definition mode
3	Visualization of the chosen skew angle on the machine radial view
4	Visualization of the equivalent axial slot angle on the rotor developed view
5	Equivalent axial stator slot angle (read only)
6	Equivalent stator slot pitch (read only)

Note: The user can add a skew angle on the rotor or on the stator. If a skew is already defined in the rotor when setting a skew on the stator, the rotor skewing will be automatically reset to “None”.

## 2.8 Winding

Please refer to the user help guide:

"MotorFactory\_2022.3\_3Phase\_Winding" which is dedicated to the 3-Phase winding design General user information.

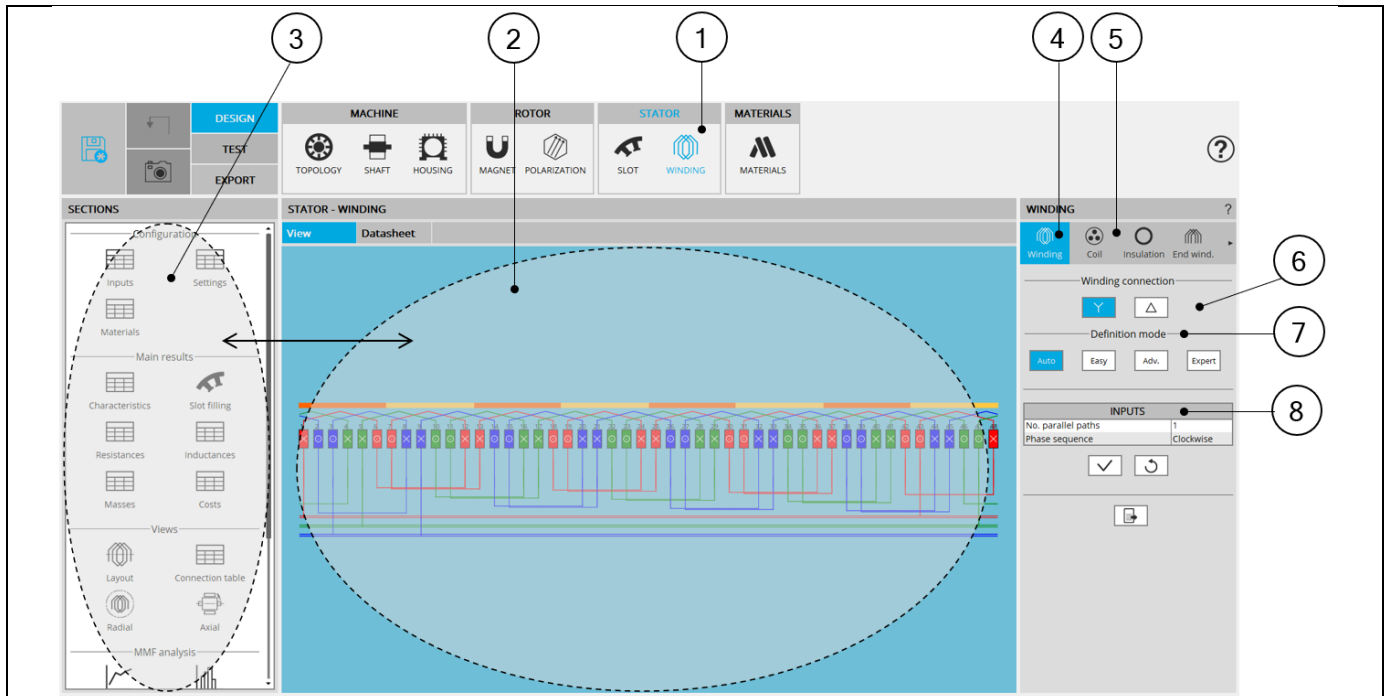

WINDING design area - Overview

1	Selection of the STATOR subset: WINDING panel (Click on the icon WINDING)
2	Once a winding is defined, corresponding results are automatically displayed in form of a winding report. Visualization of the winding characteristics (inputs, settings, materials, etc) is possible. Scrollbars allow browsing the whole document rapidly and having an overview of all the results. Using scrollbars, complete data can be accessed and visualized.
3	Shortcuts for displaying the corresponding chapter of the winding report.
4	Winding settings allow describing the winding architecture.
5	Winding settings allow describing the winding:
6	Choice of the winding connection: Y (Wye) or $\Delta$ (Delta).
7	Four modes allow <b>defining and building the winding architecture</b> .
Auto	<b>Automatic</b> mode used by default.
Easy	<b>Easy</b> mode, to choose solution among these FluxMotor® proposes.
Adv.	<b>Advanced</b> mode, to allow the user to define his own input parameters.
Expert	<b>Expert</b> mode to set the connection table.
8	User input parameter field to enter the value according to the considered mode.

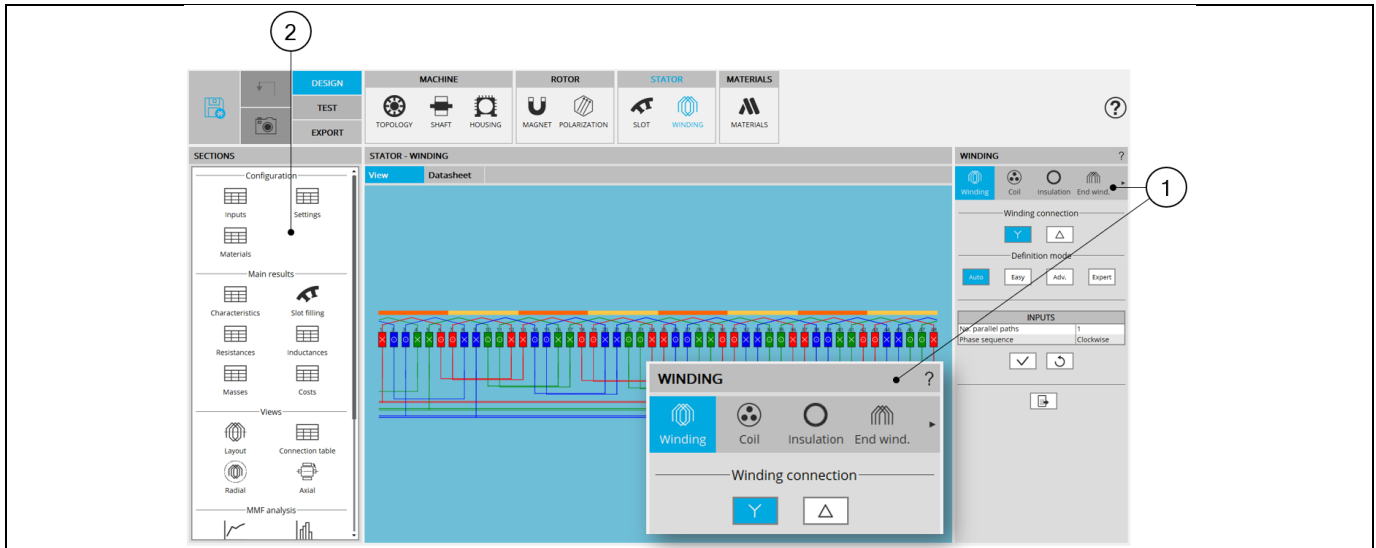

Scrolling selection bar – Winding environment

1	Selection bar where Winding, Coil, End-winding and X-Factor sections can be selected
2	Section data can be reached thanks to shortcuts

## 2.9 Materials

### 2.9.1 Overview

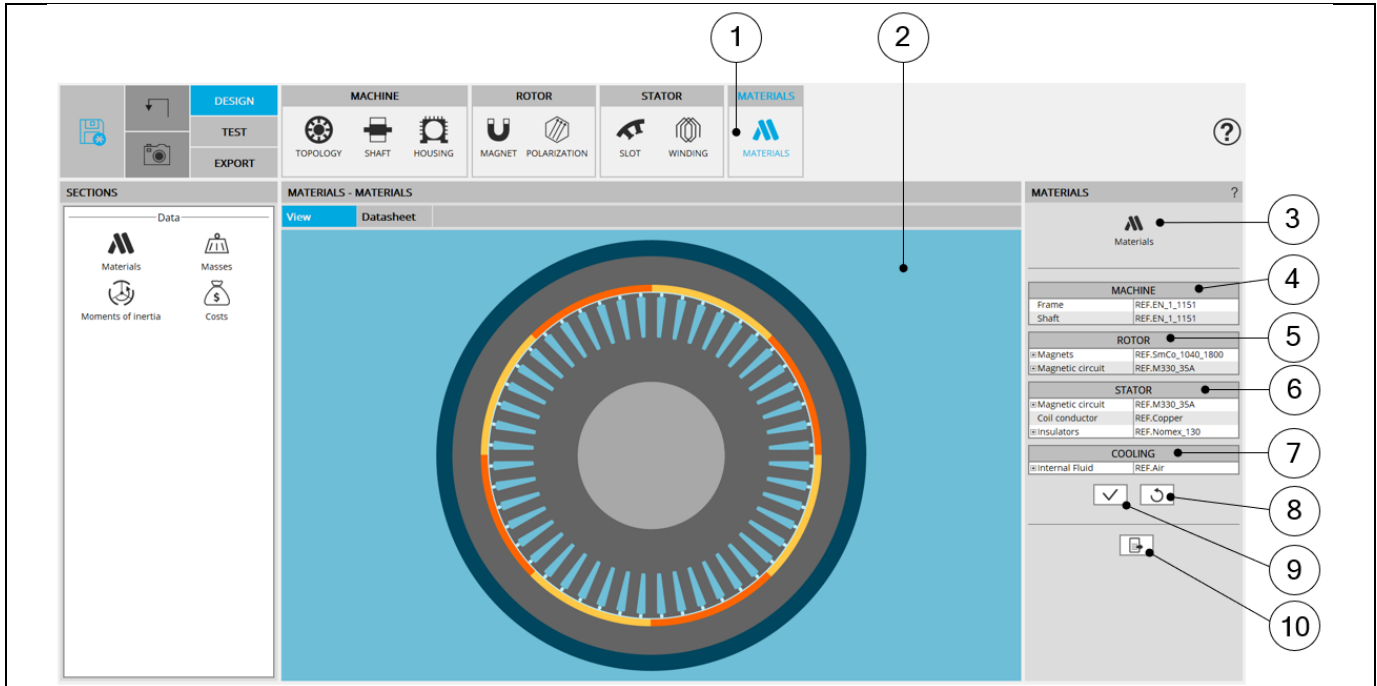

MATERIALS design area

1	Selection of the Material subset: MATERIALS panel (Click on the icon MATERIALS)
2	Visualization of the machine regions.
3	Direct access to open material manager. It allows seeing properties of materials.
4	Area to assign materials to machine regions. See additional information below.
5	Area to assign materials to rotor regions. See additional information below.
6	Area to assign materials to stator regions. See additional information below.
7	Area to assign materials to the airgap.
8	Button to restore default materials. Default materials are those defined as favorite materials in Material manager. See “Materials” application for more information.
9	Button to validate assignment of materials. Pressing the Enter key twice applies inputs too.
10	Icon to export the rotor material data into *.txt or *.xlsx files.

## 2.9.2 Rotor Inputs / Outputs

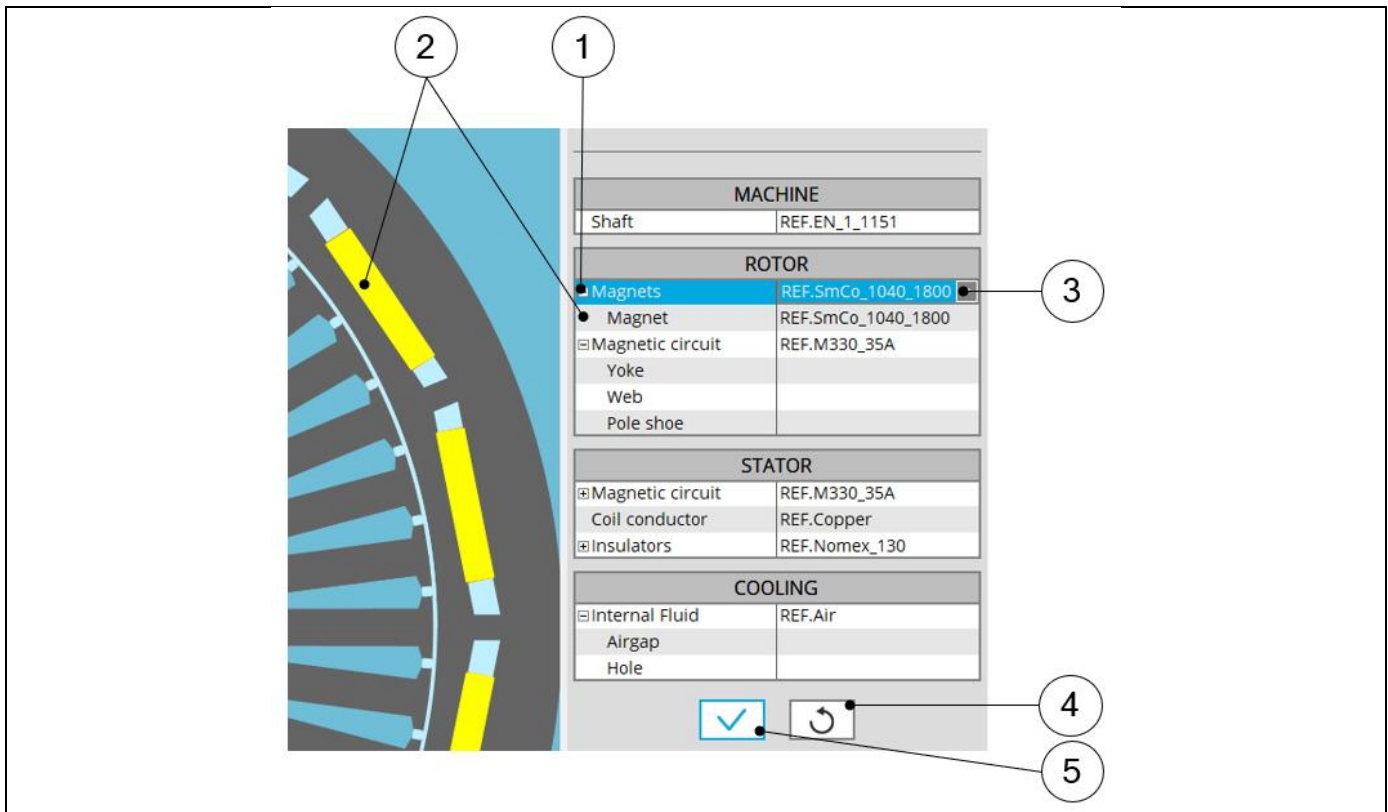

## Assign Materials to MAGNETS in the rotor

1	Expand the section dedicated to magnets. Several magnet materials can be assigned to the same rotor pole. Here four magnets are defined. Different magnet materials can be assigned to each of them.
2	By selecting a region name (Magnet1A for example) the corresponding face region is highlighted.
3	Expand the material list to choose a magnet material to assign to the selected magnet.
4	Button to restore default materials. Default materials are those defined as favorite materials in Material manager. See "Materials" application for more information.
5	Button to validate assignment of materials. Pressing the Enter key twice applies inputs too.

## 2.9.3 How to assign materials? – Example for rotor lamination

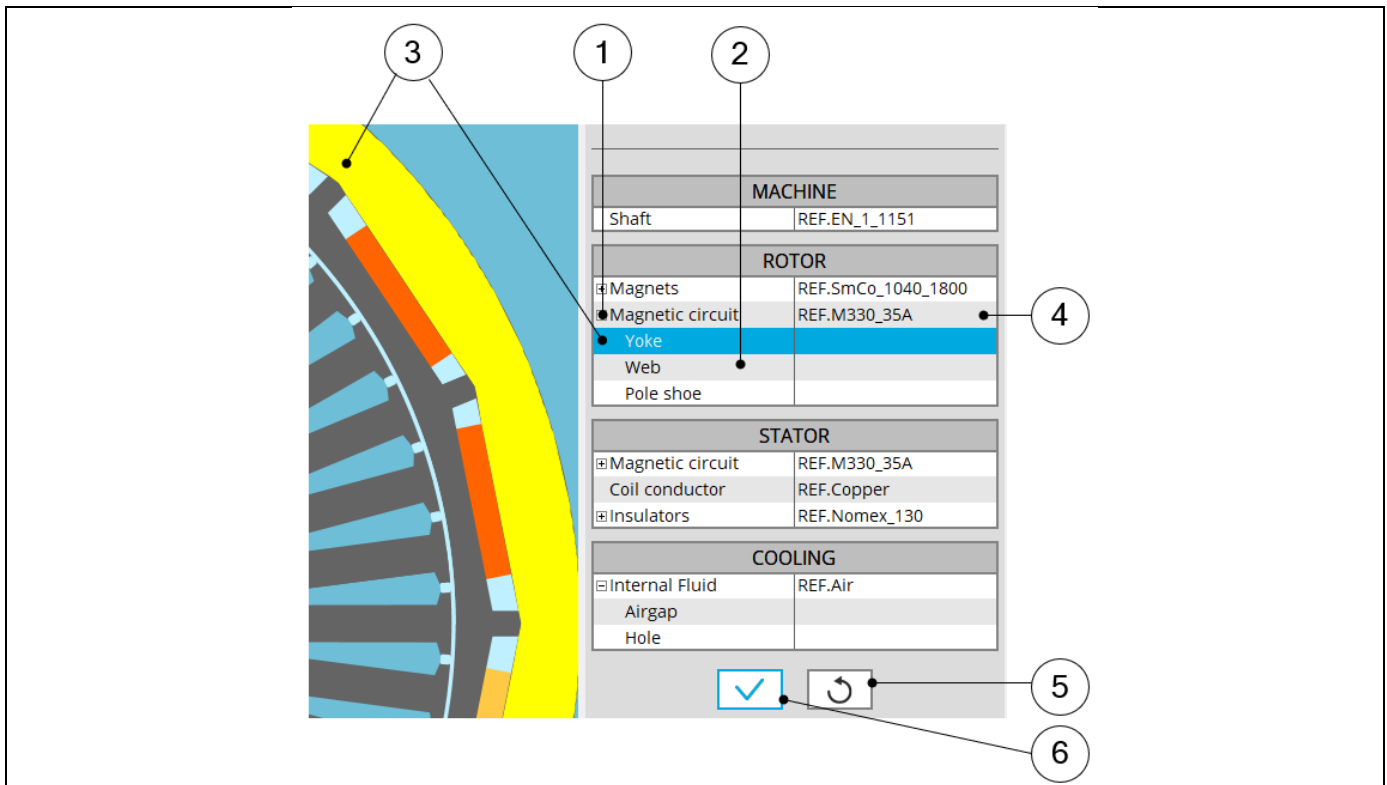

## Assign materials to the rotor magnetic circuit

1	Expand the section dedicated to the magnetic circuit. Different materials (LAMINATION type or SOLID type) can be assigned to it.
2	The magnetic circuit can be subdivided into several parts. (Yoke, Bridge, Web etc.)
3	By selecting a region name (Yoke for example) the corresponding face region is highlighted.
4	Expand the material list to choose a material to assign to the magnetic circuit. Only one material can be assigned to the rotor magnetic circuit. In our example it is not possible to assign different materials to sub regions like Yoke and Web.
5	Button to restore default materials. Default materials are those defined as favorite materials in Material manager. See "Materials" application for more information.
6	Button to validate assignment of materials. Pressing the enter key twice applies inputs too.

For more information about the rules leading to the building of parts like magnets, please refer to Part Factory application.

## 2.9.4 How to assign materials? – Example for stator laminations

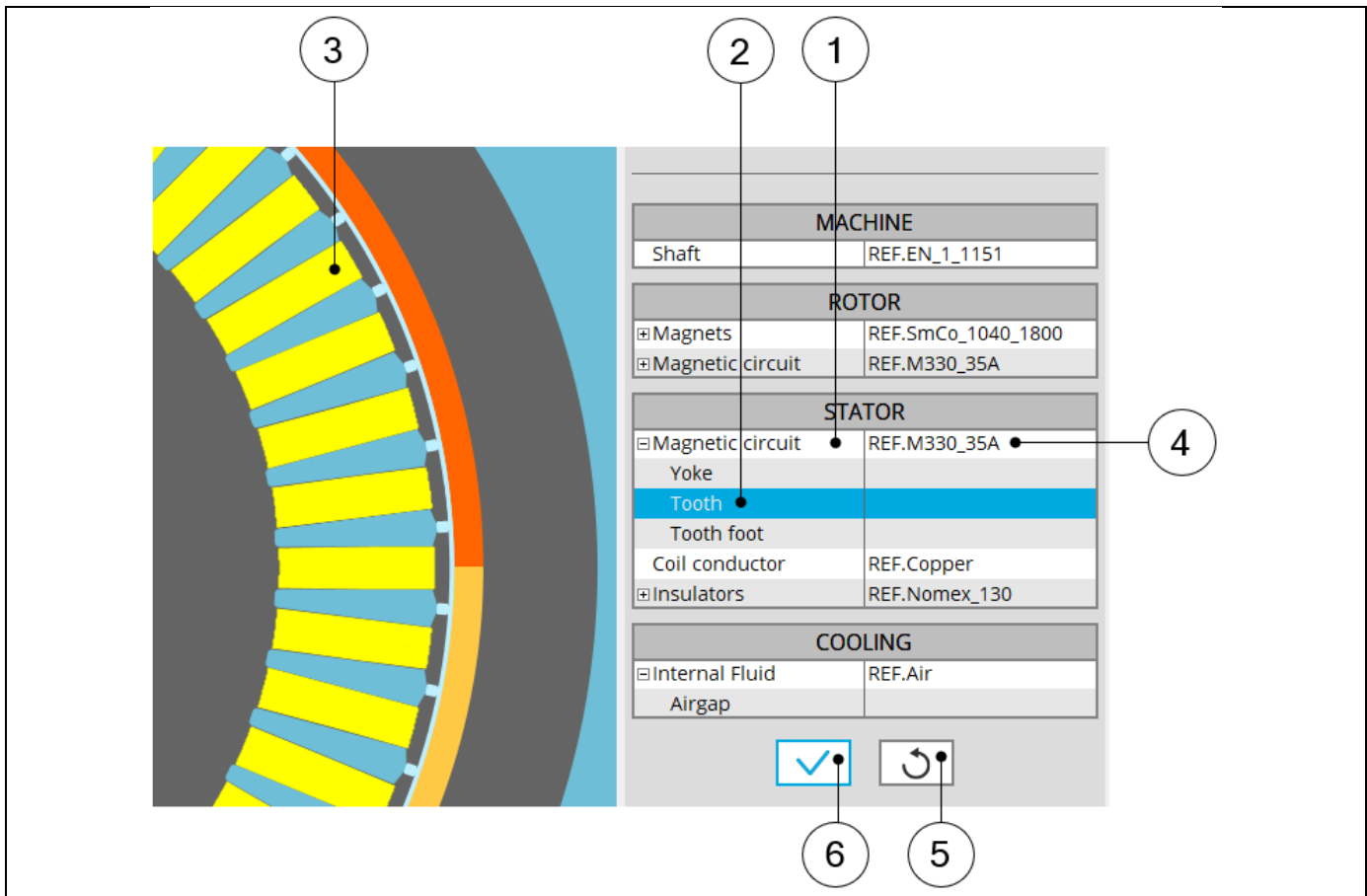

## Assign materials to the stator magnetic circuit

1	Expand the section dedicated to the magnetic circuit. Different materials (LAMINATION type or SOLID type) can be assigned to it.
2	The magnetic circuit of the stator can be subdivided into several parts (Yoke, Tooth, Tooth foot etc.).
3	By selecting a region name (Tooth for example) the corresponding face region is highlighted.
4	Expand the material list to choose a material to assign to the magnetic circuit. Only one material can be assigned to the stator magnetic circuit. In our example, it is not possible to assign different materials to sub regions like Yoke, Tooth and Tooth foot for example.
5	Button to restore default materials. Default materials are those defined as favorite materials in Material database. See "Materials" application for more information.
6	Button to validate assignment of materials. Pressing the enter key twice applies inputs too.

For more information about the rules leading to the building of parts like slots, please refer to Part Factory application.



## 2.9.5 Materials for the winding

All the materials are selected in the material database.

Conductor materials are selected in the “Electrical Conductor” type material family.  
 Insulator materials are selected in the “Electrical Insulator” type material family.  
 Thicknesses of insulations are defined inside the winding settings panel – COIL tab.  
 Insulation materials are considered only if a corresponding thickness is defined.

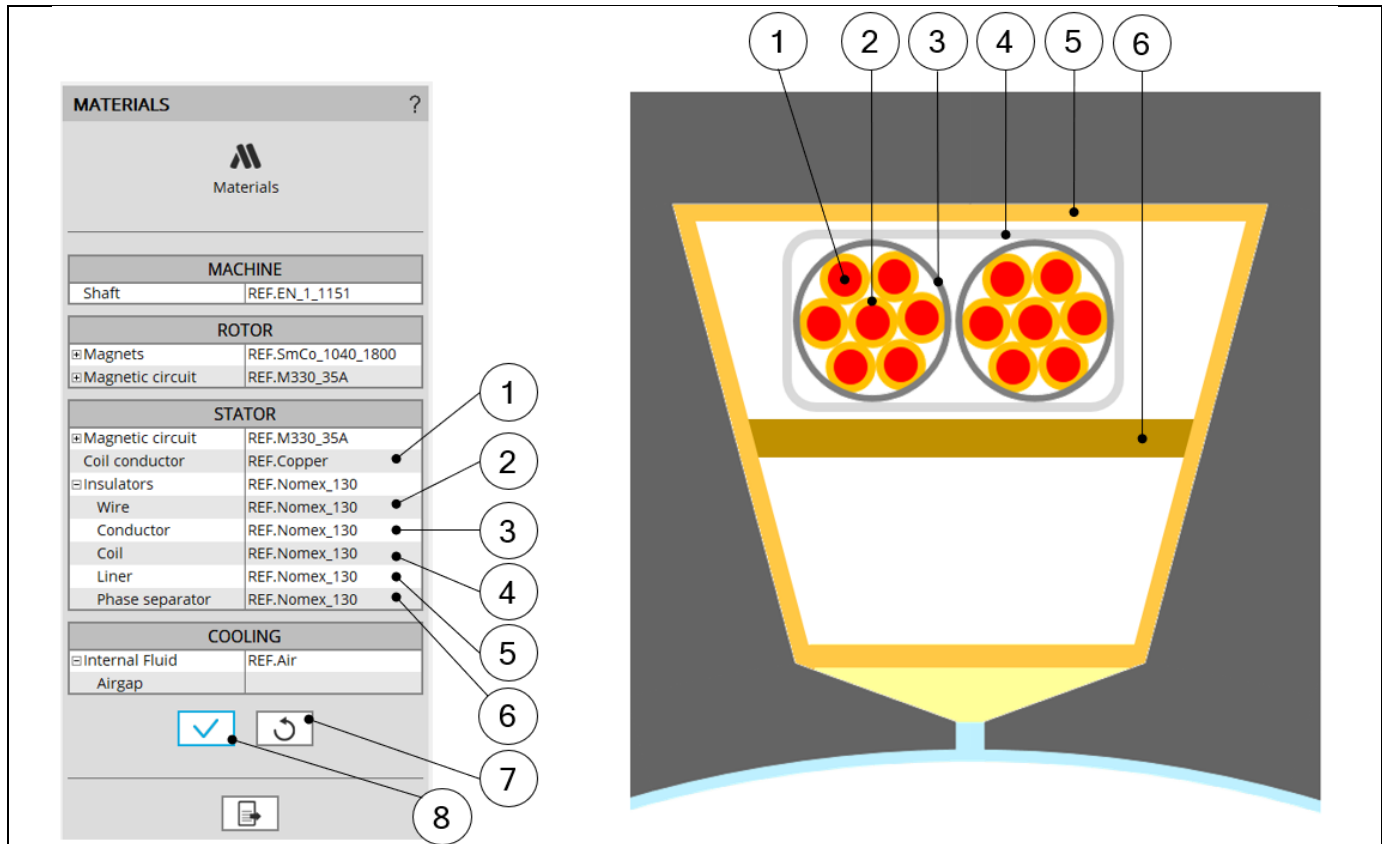

Building the winding architecture – **Choice of winding MATERIALS** - Conductor and insulation

1	Conductor materials
2	Wire insulation
3	Conductor insulation
4	Coil insulation
5	Liner
6	Phase separator
7	Button to restore default materials. Default materials are those defined as favorite materials in Material database. See “Materials” application for more information.
8	Button to validate assignment of materials. Pressing the enter key twice applies inputs too.
*	Insulators: If all the above choices are same material, then the corresponding material name is written in the insulators field. Otherwise “Diversified” is written in the insulators field which means there are different materials.

2.9.6 Material datasheet

The screenshot shows the 'MATERIALS - MATERIALS' section in the software. The 'Datashheet' view displays the following data:

Materials					
Machine					
Shaft	REF.EN_1_1151				
Rotor					
Magnets	REF.SmCo_10...	Magnetic circuit		REF.M330_35A	
Rotor - Magnets					
Magnet	REF.SmCo_10...				
Stator					
Magnetic circuit	REF.M330_35A	Coil conductor	REF.Copper	Insulators	REF.Nomex_130
Stator - Insulators					
Wire	REF.Nomex_130	Conductor	REF.Nomex_130	Coil	REF.Nomex_130
Liner	REF.Nomex_130	Phase separator	REF.Nomex_130		
Cooling					
Internal Fluid	REF.Air				

Masses					
Total					
Total (kg)	38.099	Rotor (kg)	17.107	Stator (kg)	20.993
Rotor					
Shaft (kg)	5.976	Magnets (kg)	1.83	Magnetic circuit (kg)	9.3
Rotor - Magnets					
Magnet (kg)	1.83				
Stator					
Magnetic circuit (kg)	13.581	Winding (kg)	7.412		
Stator - Winding					
Electrical conductor (kg)	7.295	Total insulation (kg)	1.167 E-1		

Moments of inertia	
Rotor	

MATERIALS design area

1	Selection of the Materials subset: MATERIALS panel (Click on the icon MATERIALS)
2	Shortcuts to reach material datasheet sections
3	Material datasheet where materials, masses, moment of inertia and costs are displayed
4	Icon to export rotor material data into *.txt or *.xlsx files.